

# OKLAHOMA ROADSIDE VEGETATION MANAGEMENT GUIDELINES - 4TH EDITION

## TECHNICAL REPORT – FHWA-OK-09-02

ODOT SPR ITEM 2156 SECTION 9: JOINT PROJECT NUMBER # 01946(52)

by

Douglas P. Montgomery  
Extension Associate

Dennis L. Martin  
Principal Investigator

Craig C. Evans  
Extension Associate

Department of Horticulture & Landscape Architecture  
Oklahoma State University  
358 Agricultural Hall  
Stillwater, OK 74078

Project Manager:  
Bryan K. Hurst, Administrative Programs Officer  
Oklahoma Department of Transportation  
Planning and Research Division



January 2010

# TECHNICAL REPORT DOCUMENTATION PAGE

<b>1. REPORT NO.</b> <b>FHWA-OK-09-02</b>	<b>2. GOVERNMENT ACCESSION NO.</b>	<b>3. RECIPIENT'S CATALOG NO.</b>	
<b>4. TITLE AND SUBTITLE</b> <b>OKLAHOMA ROADSIDE VEGETATION MANAGEMENT GUIDELINES - 4TH EDITION</b>		<b>5. REPORT DATE</b> <b>January 2010</b>	
		<b>6. PERFORMING ORGANIZATION CODE</b>	
<b>7. AUTHOR(S)</b> <b>Douglas P. Montgomery, Dennis L. Martin and Craig C. Evans</b>		<b>8. PERFORMING ORGANIZATION REPORT</b>	
<b>9. PERFORMING ORGANIZATION NAME AND ADDRESS</b> <b>Dept. of Horticulture &amp; Landscape Architecture</b> <b>Oklahoma State University, 358 Agricultural Hall</b> <b>Stillwater, OK 74078</b>		<b>10. WORK UNIT NO.</b>	
		<b>11. CONTRACT OR GRANT NO.</b> <b>ODOT Item: 2156, JP#: 01946(52),</b> <b>Contract #: 3459021609</b>	
<b>12. SPONSORING AGENCY NAME AND ADDRESS</b> <b>Oklahoma Department of Transportation</b> <b>Planning and Research Division</b> <b>200 N.E. 21st Street, Room 3A7</b> <b>Oklahoma City, OK 73105-3204</b>		<b>13. TYPE OF REPORT AND PERIOD COVERED</b> <b>Final Technical Report – 4<sup>th</sup> Edition</b>	
		<b>14. SPONSORING AGENCY CODE</b>	
<b>15. SUPPLEMENTARY NOTES</b>			
<b>16. ABSTRACT</b> <p><b>A fourth edition of the Oklahoma Roadside Vegetation Management Guidelines was developed. The guidelines serve as a training and reference manual for Oklahoma Department of Transportation (ODOT) employees that are responsible for herbicide application as a part of maintaining roadside vegetation in Oklahoma. The guidelines were developed as a cooperative project between the Oklahoma State University Roadside Vegetation Management Program and the ODOT. The guidelines provide a comprehensive review necessary for understanding and implementing an integrated roadside vegetation management program that is compliant with ODOT, Oklahoma State and Federal policies, rules and regulations. The manual stresses the important concepts of weed identification, and the integration of proper mowing practices with sound herbicide selection and responsible product use. When properly implemented, the guidelines will aid in achieving cost effective, reduced risk weed control in desirable roadside vegetation. Where applicable, biological weed control agents are discussed. Herbicide product classification, pesticide fate, environmental protection, applicator personal protective equipment, proper equipment calibration and operation are discussed. Pesticide rules and regulations pertinent to Oklahoma are addressed. Use of the ODOT Approved Herbicide and Adjuvant List is also discussed.</b></p>			
<b>17. KEY WORDS</b> <b>Roadside vegetation, weed control, herbicides, sprayers, application equipment, pesticide regulation, pesticide applicator training</b>		<b>18. DISTRIBUTION STATEMENT</b> <b>No restrictions. This publication is available from the Planning &amp; Research Division, Oklahoma DOT.</b>	
<b>19. SECURITY CLASSIF. (OF THIS REPORT)</b> <b>Unclassified</b>	<b>20. SECURITY CLASSIF. (OF THIS PAGE)</b> <b>Unclassified</b>	<b>21. NO. OF PAGES</b> <b>258</b>	<b>22. PRICE</b>

## **ACKNOWLEDGEMENTS**

The Oklahoma State University Roadside Vegetation Management Team members express their appreciation to the personnel of the Oklahoma Department of Transportation (ODOT) and the Federal Highway Administration for their interest, suggestions and cooperation in the development of this manual.

Special recognition is due Mr. Bryan K. Hurst, Planning & Research Division, who served as Project Manager.

Additionally, we would like to recognize those individuals who served as Item 2156 and 2157 Roadside Vegetation Management steering committee members: Brent Almquist, Alex Calvillo, Calvin Carney, Roy Counts, Brantley Hendrex, Melody Johnston, Kevin Kehoe, Rick Lowry, Paul Rachael, James Robinson, Dennis Scheiber, Troy Travis and Robert Ward. We would also like to thank Michele Dolan, ODOT Stormwater Program Manager and Julianne Hoagland, ODOT Wildlife & Natural Resources Biologist, for their review and input to this document.

Appreciation is also expressed to Ms. Stephanie Larimer who prepared and formatted large portions of this manuscript and to Graduate Student Santanu Bikram Thapa who served as a proof reader on portions of this work. Finally, we would like to thank Dr. Mike Schnelle and Dr. Justin Moss from the Dept of Horticulture & Landscape Architecture, Oklahoma State University, who served as internal reviewers on the draft manuscript.

## **DISCLAIMERS**

The contents of this report reflect the views of the authors who are responsible for the facts and the accuracy of the data presented herein. The contents do not necessarily reflect the views of the Oklahoma Department of Transportation or the Federal Highway Administration. This report does not constitute a standard, specification, or regulation. While trade names may be used in this report, it is not intended as an endorsement of any machine, contractor, process, or products. Hard Copies are available upon written request from the Printing Services Branch, Oklahoma Department of Transportation. The Planning and Research's Research Manual is available at cost plus shipping and handling.

In order that the information in this manual may be more useful, it was often necessary to use trade names of products, rather than chemical names. As a result, it is unavoidable in some cases that similar products which are on the market under other trade names may not be cited. No endorsement of mentioned products is intended, nor is criticism implied of similar products which are not mentioned.

As pesticide labels change frequently, it is inevitable that the legality of using a certain pesticide on a site and the legal use rates of pesticides will change over time. Therefore, it is the responsibility of the end user to read and follow all pesticide label directions.

Oklahoma State University, in compliance with Title VI and VII of the Civil Rights Act of 1964, Executive Order 11246 as amended, Title IX of the Education Amendments of 1972, American with Disabilities Act of 1990 and other federal laws and regulations, does not discriminate on the basis of race, color, national origin, sex, age, religion, disability or status as a veteran in any of its policies, practices or procedures. This includes but is not limited to admissions, employment, financial aid and educational services.

# SI (METRIC) CONVERSION FACTORS

## Approximate Conversions to SI Units

## Approximate Conversions from SI Units

Symbol	When you know	Multiply by	To Find	Symbol	Symbol	When you know	Multiply by	To Find	Symbol
<b>LENGTH</b>					<b>LENGTH</b>				
in	inches	25.40	millimeters	mm	Mm	millimeters	0.0394	inches	in
ft	feet	0.3048	meters	m	m	meters	3.281	feet	ft
yd	yards	0.9144	meters	m	m	meters	1.094	yards	yds
mi	miles	1.609	kilometers	km	km	kilometers	0.6214	miles	mi
<b>AREA</b>					<b>AREA</b>				
in <sup>2</sup>	square inches	645.2	square millimeters	mm <sup>2</sup>	mm <sup>2</sup>	square millimeters	0.00155	square inches	in <sup>2</sup>
ft <sup>2</sup>	square feet	0.0929	square meters	m <sup>2</sup>	m <sup>2</sup>	square meters	10.764	square feet	ft <sup>2</sup>
yd <sup>2</sup>	square yards	0.8361	square meters	m <sup>2</sup>	m <sup>2</sup>	square meters	1.196	square yards	yd <sup>2</sup>
ac	acres	0.4047	hectares	ha	ha	hectares	2.471	acres	ac
mi <sup>2</sup>	square miles	2.590	square kilometers	km <sup>2</sup>	km <sup>2</sup>	square kilometers	0.3861	square miles	mi <sup>2</sup>
<b>VOLUME</b>					<b>VOLUME</b>				
fl oz	fluid ounces	29.57	milliliters	mL	mL	milliliters	0.0338	fluid ounces	fl oz
gal	gallon	3.785	liters	L	L	liters	0.2642	gallon	gal
ft <sup>3</sup>	cubic feet	0.0283	cubic meters	m <sup>3</sup>	m <sup>3</sup>	cubic meters	35.315	cubic feet	ft <sup>3</sup>
yd <sup>3</sup>	cubic yards	0.7645	cubic meters	m <sup>3</sup>	m <sup>3</sup>	cubic meters	1.308	cubic yards	yd <sup>3</sup>
<b>MASS</b>					<b>MASS</b>				
oz	ounces	28.35	grams	g	g	grams	0.0353	ounces	oz
lb	pounds	0.4536	kilograms	kg	kg	kilograms	2.205	pounds	lb
T	short tons (2000lb)	0.907	megagrams	Mg	Mg	megagrams	1.1023	short tons (2000lb)	T
<b>TEMPERATURE (exact)</b>					<b>TEMPERATURE (exact)</b>				
°F	degrees Fahrenheit	(°F-32)/1.8	degrees Celsius	°C	°C	degrees Fahrenheit	9/5(°C)+32	degrees Celsius	°F
<b>FORCE and PRESSURE or STRESS</b>					<b>FORCE and PRESSURE or STRESS</b>				
lbf	poundforce	4.448	Newtons	N	N	Newtons	0.2248	poundforce	lbf
lbf/in <sup>2</sup>	poundforce per square inch	6.895	kilopascals	kPa	kPa	kilopascals	0.1450	poundforce per square inch	lbf/in <sup>2</sup>

# OKLAHOMA ROADSIDE VEGETATION MANAGEMENT GUIDELINES - 4TH EDITION

## TECHNICAL REPORT

by

Douglas P. Montgomery  
Extension Associate

Dennis L. Martin  
Principal Investigator

Craig C. Evans  
Extension Associate

Department of Horticulture & Landscape Architecture  
Oklahoma State University  
358 Agricultural Hall  
Stillwater, OK 74078

Project Manager:  
Bryan K. Hurst, Administrative Programs Officer  
Oklahoma Department of Transportation  
Planning and Research Division

January 2010

# TABLE OF CONTENTS

<u>CHAPTER</u>	<u>PAGE</u>
1.0 Introduction.....	1- 1
1.1 Importance of Integrated Roadside Vegetation Management (IRVM) .....	1- 1
1.2 ODOT IRVM Goals .....	1- 1
1.3 Integrated RVM Programs .....	1- 2
1.4 Oklahoma Noxious Weed Law.....	1- 4
2.0 Mowing Procedures (ODOT Mowing Guide - July 1993).....	2- 1
2.01 Purpose .....	2- 1
2.1 Preface .....	2- 1
2.2 Definitions .....	2- 1
2.2.1 Safety Mowing.....	2- 1
2.2.2 Transition Mowing .....	2- 1
2.2.3 Contour or Selective Mowing .....	2- 2
2.3 General Policy Statements .....	2- 3
2.3.1 Warning Signs for Mowing .....	2- 3
2.3.2 Normal Mowing Limits.....	2- 4
2.3.2.1 Normal Mowing.....	2- 4
2.3.2.2 Normal Mowing on a Slope.....	2- 4
2.3.2.3 Normal Mowing Fill Slopes .....	2- 5
2.3.2.4 Fill Slopes of 3:1 or Greater Slope.....	2- 5
2.3.2.5 Mowing Flat Areas .....	2- 6
2.3.3 Wildflowers.....	2- 6
2.3.4 Mowing Height .....	2- 7
2.3.5 Mowing Intervals .....	2- 7
2.3.6 Trees and Brush.....	2- 7
2.3.7 Adjacent Land Use.....	2- 9
2.4 Interstate and Multi-lane Facilities (Rural).....	2- 9
2.5 Mowing Standards for Two-lane Facilities (Rural) .....	2-12
2.6 Mowing Standards for Urban and Developed Areas Adjacent to Cities and Towns .....	2-14
2.7 Operator Safety .....	2-14
3.0 Integrating Mowing and Herbicide Programs.....	3- 1
3.01 Purpose .....	3- 1
3.1 Effects of Mowing on Roadside Plant Growth and Development.....	3- 1
3.1.1 Annual Grasses and Broadleaf Weeds .....	3- 2
3.1.2 Biennial Broadleaf Weeds.....	3- 3
3.1.3 Perennial Broadleaf Weeds and Grasses .....	3- 4
3.1.4 Bermudagrass and Other Desirable Grasses .....	3- 5
3.1.5 Native and Planted Wildflowers.....	3- 7

## TABLE OF CONTENTS (Continued)

<u>CHAPTER</u>	<u>PAGE</u>
3.2	Effects of Mowing on Herbicide Efficacy ..... 3-13
3.2.1	Contact Herbicides..... 3-13
3.2.2	Translocated Herbicides ..... 3-13
3.2.3	Residual Herbicides ..... 3-14
3.3	Prioritizing Mowing and Herbicide Practices ..... 3-16
3.3.1	Factors Influencing Prioritization ..... 3-16
3.3.1.1	ODOT Statewide Goals and Objectives..... 3-16
3.3.1.2	ODOT Field Division Goals and Objectives ..... 3-18
3.3.1.3	Political Influences ..... 3-19
3.3.1.4	County, Municipal, and Other Influences ..... 3-20
3.3.2	Communication of Mowing and Herbicide Program Priorities ..... 3-21
3.4	Precautions in Integrating Mowing and Herbicide Programs ..... 3-21
3.4.1	Maximizing the Effects of Mowing ..... 3-22
3.4.2	Herbicide Exposures During Mowing Applications ..... 3-23
3.4.3	Contract Mowing and/or Herbicide Programs ..... 3-23
4.0	Herbicides..... 4- 1
4.01	Purpose ..... 4- 1
4.1	Introduction ..... 4- 1
4.2	Classification of Herbicides ..... 4- 2
4.2.1	Nonselective Herbicides..... 4- 2
4.2.2	Selective Herbicides..... 4- 2
4.2.3	Types of Nonselective and Selective Herbicides ..... 4- 2
4.2.4	Contact Herbicides..... 4- 3
4.2.5	Translocated Herbicides ..... 4- 3
4.2.6	Residual Herbicides ..... 4- 4
4.3	Factors Affecting Herbicide Activity ..... 4- 5
4.3.1	Climatic Factors ..... 4- 6
4.3.2	Plant Factors ..... 4- 7
4.3.3	Soil Factors ..... 4- 9
4.3.4	Water Quality Characteristics..... 4-10
4.4	Herbicide Fate ..... 4-22
4.4.1	Leaching ..... 4-22
4.4.2	Adsorption..... 4-22
4.4.3	Photodegradation..... 4-23
4.4.4	Volatilization ..... 4-23
4.4.5	Microbial Degradation ..... 4-24
4.4.6	Absorption..... 4-25
4.4.7	Hydrolysis ..... 4-25
4.5	Drift and Off-Target Movement ..... 4-25
4.5.1	Drift ..... 4-26



## TABLE OF CONTENTS (Continued)

<u>CHAPTER</u>	<u>PAGE</u>
4.5.2	Spray Characteristics..... 4-27
4.5.3	Application Equipment and Techniques ..... 4-28
4.5.4	Weather Conditions..... 4-30
4.5.5	Movement of Soil-Applied Herbicides ..... 4-31
4.6	ODOT Herbicide Program Policy ..... 4-32
4.7	Record Keeping ..... 4-35
4.8	Herbicide Complaint Procedures ..... 4-37
4.9	Herbicide Labels ..... 4-37
5.0	Suggested Herbicide Treatments for Roadside Weed Problems..... 5- 1
5.01	Purpose ..... 5- 1
5.05	Introduction ..... 5- 1
5.1	Johnsongrass Control Using Postemergence Herbicides ..... 5- 4
5.2	Winter Annual Grasses and Broadleaf Weed Control Using Postemergence Herbicides..... 5- 8
5.3	Annual Ryegrass Control Using Postemergence Herbicides ..... 5- 9
5.4	Early Preemergence and Postemergence Control Of Winter And Summer Broadleaf Weeds ..... 5-11
5.5	General Broadleaf Weed Control Using Postemergence Herbicides..... 5-13
5.6	Musk Thistle Control Using Postemergence Herbicides ..... 5-14
5.7	Scotch Thistle Control Using Postemergence Herbicides..... 5-16
5.8	Silver Bluestem Control Using Postemergence Herbicides ..... 5-17
5.9	Switchgrass Management (Ropewick or Wiper Application)..... 5-19
5.10	General Brush Control ..... 5-20
5.11	Brush Control Using Cut Surface Treatments..... 5-23
5.12	Brush Control Using Dormant Basal Stem and/or Cut Surface Treatments..... 5-24
5.13	Bermudagrass Encroachment Control Using Postemergence Herbicides..... 5-25
5.14	Aquatic Weed Control in Standing or Moving Water..... 5-26
5.15	Postemergence Total Vegetation Control Under Cable-Barrier Systems ..... 5-28
6.0	Herbicide Adjuvants..... 6- 1
6.01	Purpose ..... 6- 1
6.05	Introduction ..... 6- 1
6.1	ODOT Drift Control Policy..... 6- 2
6.2	Compatibility of Adjuvants and Herbicides..... 6- 2
6.3	Drift Control Products..... 6- 3
6.4	Surfactants..... 6- 4

## TABLE OF CONTENTS (Continued)

<u>CHAPTER</u>		<u>PAGE</u>
6.5	Crop Oils.....	6- 5
6.6	Ammonium Sulfate .....	6- 6
7.0	Biological Weed Control .....	7- 1
7.01	Purpose .....	7- 1
7.05	Introduction.....	7- 1
7.1	Musk Thistle Head Weevil and the Musk Thistle .....	7- 1
7.2	Musk Thistle as a Weed Problem .....	7- 2
7.3	Musk Thistle Life Cycle.....	7- 2
7.4	Integrated Musk Thistle Control Strategies.....	7- 3
7.4.1	Mechanical Control .....	7- 3
7.4.1.1	Tillage.....	7- 3
7.4.1.2	Mowing .....	7- 3
7.4.1.3	Cutting.....	7- 4
7.4.2	Chemical Control.....	7- 5
7.4.2.1	Herbicide Use for Musk Thistle Control .....	7- 5
7.4.2.2	Salt for Musk Thistle Control.....	7- 5
7.4.3	Musk Thistle Head Weevil.....	7- 6
7.4.3.1	Life Cycle of the Weevil .....	7- 6
7.4.3.2	Collecting and Releasing Weevils.....	7- 7
7.4.3.3	Integrated Musk Thistle Control.....	7- 8
7.4.3.4	Weevil Release Record Keeping.....	7- 9
8.0	Herbicide Precautions .....	8- 1
8.01	Purpose .....	8- 1
8.05	Introduction.....	8- 1
8.1	Applicator Safety.....	8- 1
8.1.1	Acute Exposure and Toxicity.....	8- 3
8.1.2	Chronic Exposure and Toxicity.....	8- 5
8.1.3	Personal Protective Equipment (PPE) .....	8- 6
8.1.4	Laundrying Clothing and Cleaning PPE.....	8- 9
8.1.5	Handling, Mixing and Application Precautions .....	8-11
8.2	Minor Herbicide Spill Cleanup.....	8-13
8.3	Environmental Safety.....	8-14
8.3.1	Sensitive Areas .....	8-14
8.3.2	No Spray Buffer Zones.....	8-15
9.0	Herbicide Applicator Certification and Training.....	9- 1
9.01	Purpose .....	9- 1
9.1	Why Pesticide Applicator Certification? .....	9- 1
9.2	ODOT Herbicide Policy on Certification and Training .....	9- 2

## TABLE OF CONTENTS (Continued)

<u>CHAPTER</u>	<u>PAGE</u>
9.2.1 Initial Pesticide Applicator Certification .....	9- 2
9.2.2 Continuing Education of Certified Applicators .....	9- 4
9.3 Herbicide Applicator Recertification .....	9- 4
9.4 Herbicide Applicator Training Record Keeping .....	9- 6
10.0 Herbicide Application Equipment.....	10- 1
10.01 Purpose .....	10- 1
10.05 Introduction .....	10- 1
10.1 Spot Treatments (Low Volume) .....	10- 1
10.2 Basic Power Sprayer Design .....	10- 3
10.2.1 Tanks .....	10- 3
10.2.2 Pumps.....	10- 4
10.2.3 Agitators.....	10- 6
10.2.4 Strainers.....	10- 7
10.2.5 Hoses.....	10- 9
10.2.6 Valves and Pressure Gauges .....	10-10
10.2.7 Nozzles .....	10-12
10.3 Handgun Treatments (High Volume) .....	10-12
10.4 Broadcast Treatments.....	10-14
10.5 Spray System Pressures .....	10-15
10.6 Nozzle Tips and Sizes for Roadside Herbicide Applications....	10-17
10.6.1 Flat-Fan Nozzle Spray Tips.....	10-17
10.6.2 Boom Buster Spray Nozzles .....	10-20
10.6.3 Solid-Stream Spray Nozzles .....	10-23
10.6.4 Off-Center Spray Nozzles .....	10-24
10.7 Checklist for Sprayer Problems .....	10-25
10.8 Proper Sprayer Cleaning, Storage and Maintenance Procedures .....	10-28
10.8.1 Cleaning Herbicide Sprayer Equipment .....	10-28
10.8.2 Storage and Maintenance of Sprayer Equipment.....	10-30
11.0 Herbicide Application Equipment Calibration.....	11- 1
11.01 Purpose .....	11- 1
11.05 Introduction .....	11- 1
11.1 Factors That Influence the Amount of Herbicide Applied to an Area .....	11- 1
11.1.1 Nozzle Flow Rate .....	11- 2
11.1.2 Carrier Rate .....	11- 3
11.1.3 Ground Speed.....	11- 3
11.1.4 Spray Pattern Width or Nozzle Spacing .....	11- 4
11.2 Calibration for Spot Treatment Applications.....	11- 5

## TABLE OF CONTENTS (Continued)

<u>CHAPTER</u>	<u>PAGE</u>
11.3 Boom-type Applications .....	11- 8
11.3.1 Calibration of Boom-type Sprayers .....	11- 8
11.4 Boomless Type Applications.....	11-11
11.4.1 Off-Center Nozzle Sprayers .....	11-11
11.4.1.1 Calibration of Boomless Off-Center or Boom Buster Nozzle Sprayers .....	11-12
11.4.2 Boom Buster Nozzle Sprayers .....	11-14
11.4.2.1 Calibrating Boom Buster Nozzle Sprayers.....	11-15
11.4.3 Solid-Stream Nozzle Sprayers .....	11-16
11.4.3.1 Calibration of Solid-Stream Nozzle Sprayers...	11-17
11.4.4 Speed Adjustment Charts .....	11-20
11.5 Ropewick or Wiper-Type Applicators.....	11-27
11.6 Digital Speed Controls and Monitors .....	11-29
12.0 Pesticide Laws and Regulations.....	12- 1
12.01 Purpose .....	12- 1
12.1 Federal Pesticide Laws.....	12- 1
12.1.1 Endangered Species Act .....	12- 2
12.1.2. Oklahoma Pollutant Discharge Elimination System (OPDES) Regulations .....	12 - 5
12.2 Oklahoma Pesticide Laws and Regulations.....	12- 6
12.2.1 Oklahoma’s Noxious Weed Law .....	12- 6
12.2.2 ODOT Pesticide Applicator Licensing and Certification Requirements.....	12- 8
12.2.3 Herbicide Application Record Keeping.....	12- 9
12.2.4 Herbicide Container Storage .....	12-11
12.2.5 Herbicide Container Disposal and Recycling .....	12-12
12.2.6 Major Herbicide Spill Cleanup.....	12-14
12.2.7 Backflow Prevention.....	12-15
12.2.8 ODOT Herbicide Spray Packet Information .....	12-16
13.0 Public Relations and Herbicides .....	13- 1
13.01 Purpose .....	13- 1
13.05 Introduction.....	13- 1
13.1 Public Perception of Herbicides.....	13- 1
13.2 Proactive or Reactive Herbicide Public Relation Programs .....	13- 2
13.3 Formal Complaint Procedures with the ODAFF.....	13- 4
13.4 Informal Complaint Procedures with the ODOT .....	13- 5
13.5 Contact List for Questions About Herbicides .....	13- 7
13.6 No-spray Roadsides/Good Neighbor Procedures.....	13- 8

## TABLE OF CONTENTS (Continued)

<u>CHAPTER</u>	<u>PAGE</u>
14.0 ODOT Approved Herbicide and Adjuvant List (AHAL) Program.....	14- 1
14.01 Purpose .....	14- 1
14.1 Introduction .....	14- 1
14.2 ODOT Approved Herbicide and Adjuvant List (AHAL) Policy ..	14- 2
Appendix A Requirements For Efficacy Data Packet .....	A – 1
Appendix B Requirements For Compatibility Research Packet .....	B – 1
Appendix C Procedures For Tank Mix Compatibility Jar Test .....	C – 1

## LIST OF FIGURES

<b><u>FIGURE</u></b>		<b><u>PAGE</u></b>
Figure 2.1.	Safety, Contour, Transition Or Selective Mowing On Two Lane And Four Lane Highways.....	2- 2
Figure 2.2.	Warning Signs For Use When Mowing.....	2- 3
Figure 2.3.	Normal Mowing Limits For a Ditch Less Than 5 Feet Deep.	2- 4
Figure 2.4.	Normal Mowing Limits For a Ditch With Depth Of 5 Feet Or Greater.....	2- 5
Figure 2.5.	Mowing Limits On Fill Sections With A 3:1 Or Greater Slope.....	2- 5
Figure 2.6.	Mowing Limits On Flat Areas.....	2- 6
Figure 2.7.	Mowing In Designated Wildflower Areas.....	2- 8
Figure 2.8.	Selective Mowing At Interchange Sites.....	2-10
Figure 2.9.	Safety, Selective And Contour Mowing At Multi-Lane Interchanges.....	2-11
Figure 2.10.	Safety, Contour, Selective And Transition Mowing On Rural Two-Lane Facilities .....	2-13
Figure 3.1.	Excerpted Memorandum Of Understanding Between ODWC And ODOT .....	3-25
Figure 4.1.	Four Growth Stages Of A Weed. ....	4- 8
Figure 4.2	Parts Of A Grass Plant. ....	4- 9
Figure 4.3	Parts Of A Broadleaf Plant. ....	4- 9
Figure 4.4.	Oklahoma Department Of Transportation Pesticide Application Record.....	4-36
Figure 5.1.	Seasonal Herbicide Spray Zones.....	5- 2
Figure 10.1.	Backpack Sprayer Used For Making Spot Herbicide Treatments.....	10- 2

## LIST OF FIGURES (Continued)

<b><u>FIGURE</u></b>		<b><u>PAGE</u></b>
Figure 10.2.	Basic Spraying System With Hydraulic Motor Driven Centrifugal Pump.....	10- 3
Figure 10.3.	Cutaway View Of Centrifugal Pump, Belt-Driven (a) And (b) Hydraulic.....	10- 6
Figure 10.4.	Spray System Strainer; (a) Exterior View And (b) Cut-Away View Showing Strainer Mess .....	10- 8
Figure 10.5.	A Throttle Valve.....	10-10
Figure 10.6	A Shutoff Valve Activated By An Electric Solenoid.....	10-11
Figure 10.7.	A Liquid Filled Pressure Gauge.....	10-11
Figure 10.8.	Commonly Used Hand Spray Guns For Applying High Volume Herbicide Treatments.....	10-13
Figure 10.9.	A Disc Tip Used In A Hand Spray Gun For Producing A Solid Stream Pattern .....	10-14
Figure 10.10.	A Regular Flat-Fan Spray Tip Produces A Flat Pattern Tapered At The Edges.....	10-18
Figure 10.11.	Spray Patterns From Adjacent Nozzles Must Be Overlapped To Produce Uniform Spray Coverage.....	10-18
Figure 10.12.	A Flooding Flat-Fan Nozzles Produces A Wide-Angle Flat Spray Pattern.....	10-19
Figure 10.13.	Recommended Nozzle Spacing On A Boom Containing Flooding Flat-Fan Nozzles Is 40 Inches In Order To Achieve 100% Pattern Overlap.....	10-19
Figure 10.14.	Flooding Nozzle Operating Positions.....	10-20
Figure 10.15.	The Boom Buster Spray Tip.....	10-22
Figure 10.16.	Matching Boom Buster Spray Tips To Ground Speed And Pattern Width.....	10-22

## LIST OF FIGURES (Continued)

<b><u>FIGURE</u></b>		<b><u>PAGE</u></b>
Figure 10.17.	A System Using Three Different Boom Buster Tips Allows For Flexibility.....	10-22
Figure 10.18.	The (a) Solid-Stream Nozzle Is Used For (b) Boomless Broadcast Herbicide Applications.....	10-23
Figure 10.19.	The Off-Center Nozzle Is Used For Making Boomless Broadcast Herbicide Applications.....	10-24
Figure 11.1.	Nomograph For Calibrating Handgun Or Small Capacity Sprayer Applications Made On An Area Basis.....	11- 7
Figure 11.2.	Nomograph For Calibrating Boom-Type Sprayers.....	11-10
Figure 11.3.	Typical Ropewick Applicator Showing The Components Assembled... ..	11-28
Figure 12.1.	Sample 1998 ODOT Pesticide Applicator's License.....	12- 8
Figure 12.2.	An Example Of A Power Rinse Nozzle Used In Removing Herbicide Resides From The Container.....	12-14



## LIST OF TABLES

<b><u>TABLE</u></b>		<b><u>PAGE</u></b>
Table 3.1.	Proposed Mowing Schedule For Mechanical (Mowing) Weed Control.....	3- 8
Table 3.2.	Commonly Used Herbicides And Appropriate Mowing and Treatment Intervals.....	3-15
Table 4.1.	Classification Of Herbicide Uptake and Activity.....	4- 4
Table 4.2.	Herbicide Mode Of Action And Herbicide Resistance in Plants.....	4- 5
Table 4.3.	Water Quality Characteristics For 2005 Division One Water Samples.....	4-13
Table 4.4.	Water Quality Characteristics For 2005 Division Two Water Samples.....	4-14
Table 4.5.	Water Quality Characteristics For 2005 Division Three Water Samples.....	4-15
Table 4.6.	Water Quality Characteristics For 2005 Division Four Water Samples.....	4-16
Table 4.7.	Water Quality Characteristics For 2005 Division Five Water Samples.....	4-17
Table 4.8.	Water Quality Characteristics For 2005 Division Six Water Samples.....	4-18
Table 4.9.	Water Quality Characteristics For 2005 Division Seven Water Samples.....	4-19
Table 4.10.	Water Quality Characteristics For 2005 Division Eight Water Samples.....	4-20
Table 4.11.	Partial Listing Of Commercially Available Adjuvants and Their Potential Effects On Water Quality and Spray Characteristics.....	4-21

## LIST OF TABLES (Continued)

<b><u>TABLE</u></b>	<b><u>PAGE</u></b>
Table 5.1. Trade Names, Active Ingredients And Companies That Market Commonly Used Herbicides In Oklahoma Roadside Vegetation Management And That Are Found On The Approved Herbicide And Adjuvant List As Of May 2009.....	5- 3
Table 8.1. LD <sub>50</sub> Values For Commonly Used ODOT Herbicides And Drift Control Products.....	8-17
Table 8.2. Relative Lethal Acute Dose Of Herbicide For 150 Pound Man.....	8-18
Table 8.3. Signal Words From Specific Brand Name Herbicide Labels.....	8-18
Table 8.4. Personal Protective Equipment.....	8-19
Table 8.5. Sensitive Areas And Precautions On Roadside Rights-Of-Way.....	8-20
Table 9.1. Recertification Information For Pesticide Applicators.....	9- 5
Table 11.1. Speed Chart For Use With Off-Center OC-150 Or Boombuster 260-11R And 375-R Tips When Using A 20 GPA Carrier Rate.....	11-22
Table 11.2. Speed chart for use with Off-Center OC-150 or Boombuster 260-11R, 375-R, or 437-R tips when using a 25 GPA carrier rate.....	11-23
Table 11.3. Speed chart for use with Off-Center OC-150 or Boombuster 260-11R, 375-R, or 437-R tips when using a 30 GPA carrier rate.....	11-24
Table 11.4. Speed chart for use with Off-Center OC-300 or OC-150 or Boombuster 260-11R, 375-R, or 437-R tips when using a 35 GPA carrier rate.....	11-25

## LIST OF TABLES (Continued)

<b><u>TABLE</u></b>		<b><u>PAGE</u></b>
Table 11.5.	Speed chart for use with Off-Center OC-300 or OC-150 or Boombuster 260-11R, 375-R, or 437-R tips when using a 40 GPA carrier rate.....	11-26
Table 12.1.	Endangered (E) or Threatened (T) Species in Oklahoma. June 2005.....	12- 4
Table 12.2.	Noxious Weeds of Oklahoma (June 2005).....	12- 7
Table 12.3.	Suggested Reference materials to Be Carried "On-board" by Every ODOT Spray Crew.....	12-17

# CHAPTER 1.0 INTRODUCTION

## 1.1 IMPORTANCE OF INTEGRATED ROADSIDE VEGETATION MANAGEMENT (IRVM)

Integrated Roadside Vegetation Management (IRVM) is a collective process that uses the most appropriate scientifically-based vegetation management techniques to meet the department's goals in both an environmentally and economically sound manner. IRVM recognizes that every component of a program can be greatly dependent upon the other components. Whether cultural, chemical or biological, all components are used to manipulate the roadside plant community during a short period of time to achieve long-term goals. If the guidelines in this manual are followed, they will help ensure that the department is accountable and that goals are met as efficiently and economically as possible.

## 1.2 ODOT IRVM GOALS

In an effort to satisfy both department and public needs the following are the department's IRVM goals:

1. Safety for the traveling public and for employees

OBJECTIVES:

Maintain sight distance  
Minimize roadside vegetation hazards  
Decrease driver fatigue  
Safe herbicide use

2. Maintain highway vegetation in an environmentally sensitive and uniform matter

OBJECTIVES:

- Erosion control
- Increase biodiversity through protection and reintroduction of native grasses and forbs in appropriate areas
- Control invasive and noxious weeds
- Maintain or improve water quality
- Maintain or improve wildlife habitat where appropriate

3. Provide economic benefits through the cost efficient use of taxpayer dollars

OBJECTIVES:

- Increased productivity through planned and coordinated work
- Quality improvements
- Protect and extend life of the infrastructure (pavement)
- Sustainable vegetation communities

4. Create or Preserve aesthetically pleasing roadsides

OBJECTIVES:

- Reflect local character and natural heritage
- Practice "good neighbor" land use
- Provide seasonal variation in form, color and texture

### **1.3 INTEGRATED RVM PROGRAMS**

For more than 30 years maintenance crews across the state have combined mowing and selective herbicide applications into very effective vegetation management programs. One of the many goals of an IRVM program is to produce and maintain a dense stand of desirable grasses with minimal amounts of undesirable weeds remaining in the operational zone of the roadside. By definition, a weed can be any plant if it is growing where it is not wanted. The department further defines a weed to include one or more of the following criteria: 1) any plant which causes a decline in the predominant

roadside desirable grass species; 2) any plant which because of its height creates a sight-distance problem, 3) any plant which causes destruction of any road surface, bridge, or other roadside structure; 4) any plant which has significance in Oklahoma's diverse agriculture industry; and 5) any plant which has been included in Oklahoma's Noxious Weed Law. Weeds are of particular concern in the operational (clear) zone of the roadside. The operational zone begins at the edge of the road surface and usually continues through the roadside ditch (if present). This zone could be 10, 20 or even 30 feet wide depending on the particular highway. Whatever the width, the operational zone, because of the close proximity to the road surface, will receive a higher level of maintenance than non-operational zone areas. At that point, it would seem feasible to reduce mowing and herbicides to an "as-needed" basis. However, most highways, whether a four-lane interstate or rural two-lane, will have construction or maintenance activity occurring to the road surface or roadside very frequently. Activities such as shoulder repair or replacement, installation of side approaches, cleaning of drainage channels, erosion control, slide repair, reconstruction and realignment all take their toll on the roadside vegetation and soil surface. A roadside which was in good condition before these practices occurred, usually regresses many years following their completion. This roadside now requires a programmed approach to restore the desirable grass species. This could include resprigging or sodding prior to a systematic program of herbicide treatments in conjunction with mowing. To get the maximum benefit from an IRVM program, it is important that all roadside vegetation maintenance activities be scheduled prior to the growing season. This allows for prioritization of critical operations and coordination of mowing, chemical, and biological programs.

## **1.4 OKLAHOMA NOXIOUS WEED LAW**

Oklahoma, along with most bordering states, has a law that requires that specific weed species, referred to as Noxious Weeds, be prevented from producing seed. Musk thistle, Scotch thistle, and Canada thistle are declared Noxious Weeds in Oklahoma. Noxious Weeds pose a serious threat to the agricultural industries of Oklahoma. A goal of the department is to comply with the Oklahoma Noxious Weed Law using all available management techniques. The details of the Oklahoma Noxious Weed Law are covered in Chapter 12.2.1.

# **CHAPTER 2.0 MOWING PROCEDURES:**

## **ODOT MOWING GUIDE - JULY 1993**

### **2.01 PURPOSE**

The purpose of this chapter (the ODOT Mowing Guide) is to establish guidelines for uniform mowing with priorities for safety, appearance, and economy.

### **2.1 PREFACE**

The initial determination of mowing limits will require decisions being made in the field by the Division Maintenance Engineer, who will physically view, in the company of each Maintenance District Superintendent, that superintendent's area of responsibility and, using the manual as a guide, establish the minimum mowing acreage that will provide the maximum safety, scenic enhancement, and economy in the overall mowing operations.

### **2.2 DEFINITIONS**

#### **2.2.1 Safety Mowing**

Safety mowing is that required to assure traffic control devices, guardrail, and signs are visible. Also to provide adequate sight distance at the junction of intersecting roads, around curves, and at interchanges (Figure 2.1).

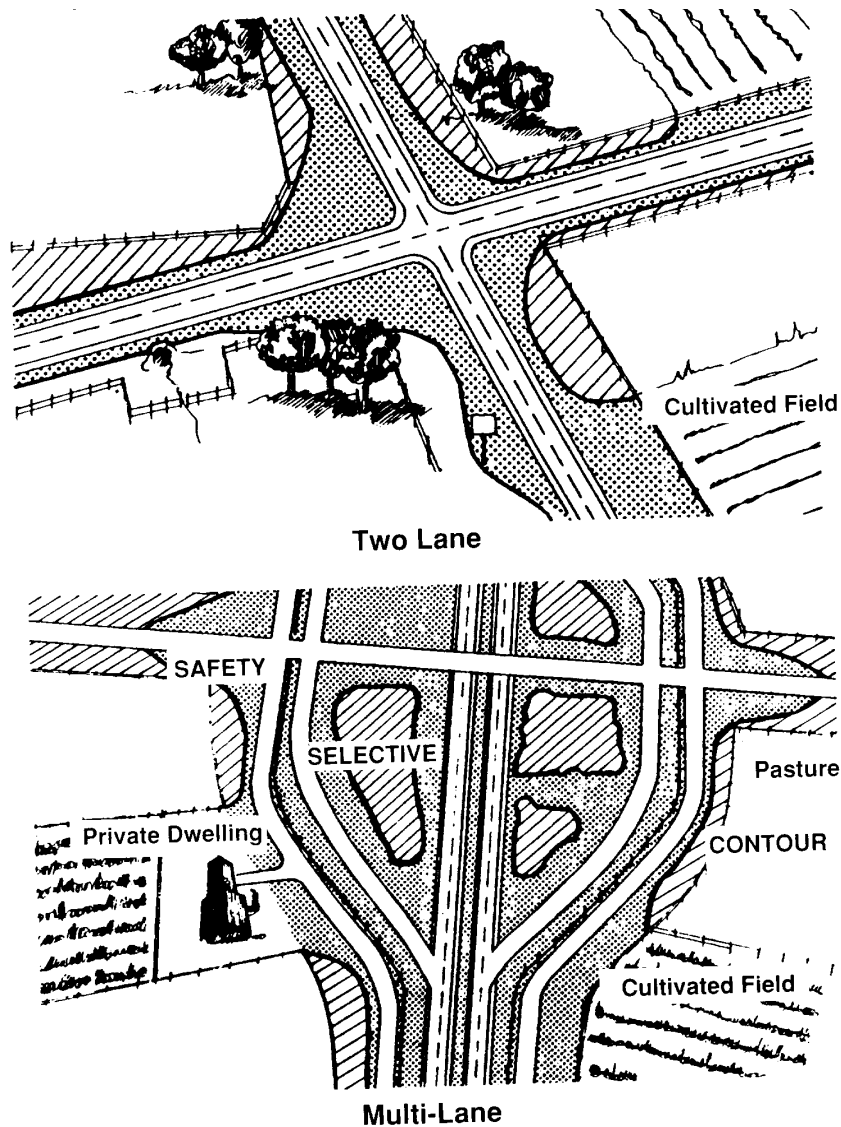
#### **2.2.2 Transition Mowing**

Transition mowing is performed to avoid abrupt changes in the width of mowed areas required for safety as defined in Section 2.2.1 "Safety Mowing" (Figure 2.1).



### 2.2.3 Contour or Selective Mowing

Contour or selective mowing is a natural blending of the maintained roadside with the established native growth. The blending is accomplished by connecting varying mowing widths, as dictated by terrain and adjacent land use, with wide sweeping curves to accentuate the natural appearance of the roadside (Figure 2.1).



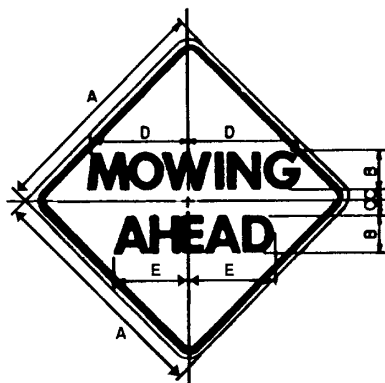
**Figure 2.1.** Safety, Contour, Transition or Selective Mowing on Two Lane and Four Lane Highways.

## 2.3 GENERAL POLICY STATEMENTS

### 2.3.1 Warning Signs for Mowing

The CW 21-7 and CW 21-7E, "MOWING AHEAD," sign is to be used in advance of mowing operations on the rights-of-way (Figure 2.2). These signs will normally be strategically placed on the shoulder of the roadway permitting the passing driver to easily read the message. As the work progresses, the signs will be moved to maintain the same relative spacing between the sign and the work area. The sign will be mounted on a substantial portable support and will be displayed only when work is in progress, not during lunch or when work has stopped.

Roll-up signs of equal size to CW 21-7 and CW 21-7E, along with portable bases, are acceptable substitutes.



COLOR:     LEGEND AND BORDER     BLACK (NON-REFLECTORIZED)  
               BACKGROUND             ORANGE (NON-REFLECTORIZED)

SIGN SIZE	DIMENSIONS					SERIES LINE 1	SERIES LINE 2	MARGIN	BORDER	BLANK STD
	A	B	C	D	E					
36 X 36	36	6	2	12-1/2	10-11/16	C	C	5/8	7/8	83-36(D)
48 X 48	48	8	3	16-11/16	14-1/4	C	C	3/4	1-1/4	83-48(D)

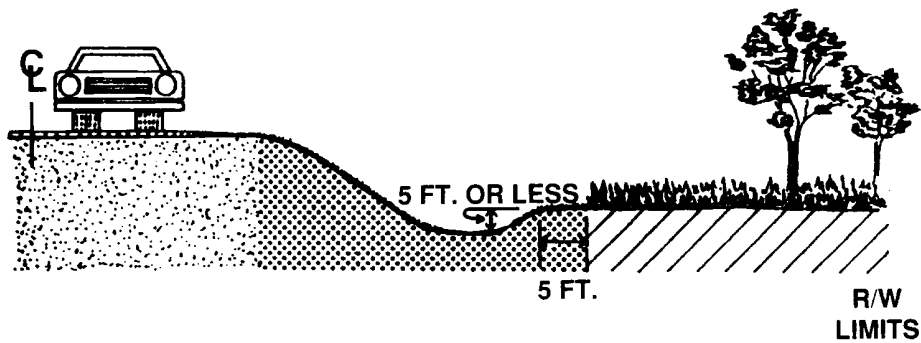
**Figure 2.2.** Warning Signs For Use When Mowing.

### 2.3.2 Normal Mowing Limits

The normal mowing limits will vary with existing terrain. These mowing limits may be grouped into five basic categories with the extent of mowing established by the depth of ditch, steepness of fill slope, and the flat areas.

#### 2.3.2.1 Normal Mowing

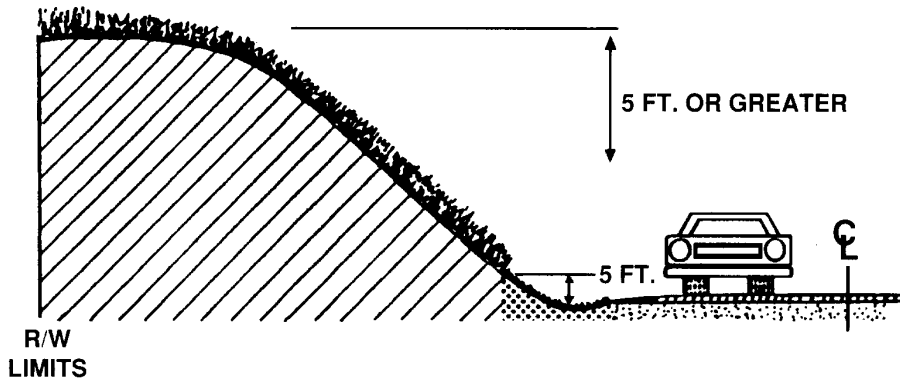
Normal limits of a ditch less than five feet deep will be confined to within five feet beyond the top of the ditch backslope (Figure 2.3).



**Figure 2.3.** Normal Mowing Limits For A Ditch Less Than Five Feet Deep.

#### 2.3.2.2 Normal Mowing on a Slope

When the ditch is five feet or greater, the mowing limit will be five feet up the face of the ditch backslope from the bottom of the ditch (Figure 2.4).



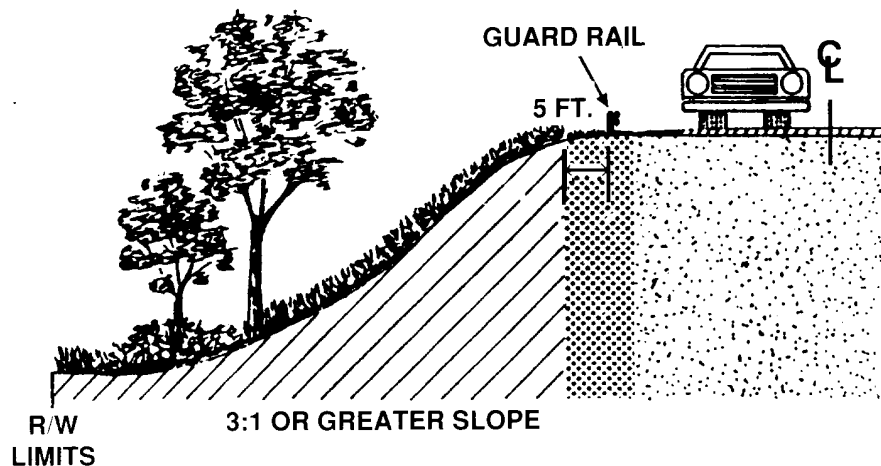
**Figure 2.4.** Normal Mowing Limits for a Ditch With Depth of Five Feet or Greater.

### 2.3.2.3 Normal Mowing Fill Slopes

In normal fill sections, a single pass of 15 feet adjacent to the shoulder will be sufficient.

### 2.3.2.4 Fill Slopes of 3:1 or Greater Slope

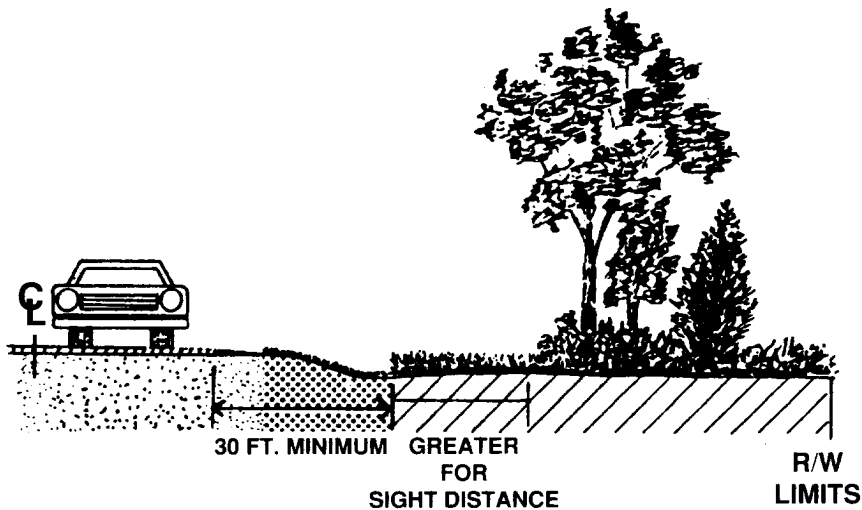
Mowing limits on fill sections with a 3:1 or greater slope will be five feet beyond the guard rail (Figure 2.5). If the steepness of the slope creates a hazard to the mowing operator, the area beyond the guardrail will be controlled by chemical means.



**Figure 2.5.** Mowing Limits On Fill Sections With A 3:1 Or Greater Slope.

### 2.3.2.5 Mowing Flat Areas

In flat areas, mowing will be practiced a minimum of 30 feet from the edge of the pavement. Mowing can be performed at a greater distance where required to maintain a safe sight distance or to create a natural blending of the maintained roadside (Figure 2.6).



**Figure 2.6.** Mowing Limits On Flat Areas.

### 2.3.3 Wildflowers

The Department of Transportation's longstanding Roadside Wildflower Program encourages preservation and planting of wildflowers. As part of that program, wildflower seed is donated by communities and other interested groups. Mowing will be delayed in these planted areas until the wildflower seed has matured (usually July). Herbicides will not be used in these areas.

Where the right-of-way is covered with naturally established wildflowers, mowing also will be delayed until the seeds have matured.

In both natural and planted areas, mowing will not be performed unless weed and vegetation height requires, and then will be limited to one pass, except for safety mowing at curves and intersections (Figure 2.7). One fall cleanup mowing is desirable in wildflower areas so that wildflowers have less competition for sunlight during the growing season.

The Department of Transportation is continuing to participate in the Roadside Habitat program sponsored by the Oklahoma Wildlife Conservation Department. Highway backslopes statewide should be left unmowed, ungrazed, and untilled for the establishment of wildlife habitats.

All of the wildflower and some of the wildlife sites can be identified with DOT Roadside Management signs marked with the appropriate decal (Figure 2.7). The signs shall be mounted with the bottom of the sign five feet above ground level. All planted sites should be identified with DOT Roadside Management signs.

#### **2.3.4 Mowing Height**

The mowing height will not be less than 6 inches.

#### **2.3.5 Mowing Intervals**

Safety mowing when required will maintain growth at a height of less than 12 inches. This mowing is limited to safety mowing as defined, and sod shoulders.

#### **2.3.6 Trees and Brush**

Trees and brush should not be allowed to grow on fill slopes or in drainage ditches. When appropriate, mowing, manual removal and herbicides may be used to suppress undesirable plants in these areas.



Figure 2.7. Mowing In Designated Wildflower Areas.

### **2.3.7 Adjacent Land Use**

The use and condition of private land just beyond the highway right-of-way has a very definite influence on the mowing lines. If adjacent land is being used for private dwellings, business, or is under active agricultural use (cultivated field, orchard, etc.), the entire right-of-way will be mowed to control weeds and brush so as to be a “good neighbor.”

## **2.4 INTERSTATE AND MULTI-LANE FACILITIES (RURAL)**

The CW 21-7E (48” x 48”) warning sign will be used on Interstate and multi-lane highways where traffic volumes are high. On these high speed facilities the advance warning distance for sign placement will be 1500 feet. When mowing in the median, signs will be placed for both directions of traffic.

Medians will be mowed a minimum of 25 feet from the median edge of the roadway line in all medians 50 feet or wider (Figure 2.8). Regeneration of native growth in medians wider than 60 feet should be considered.

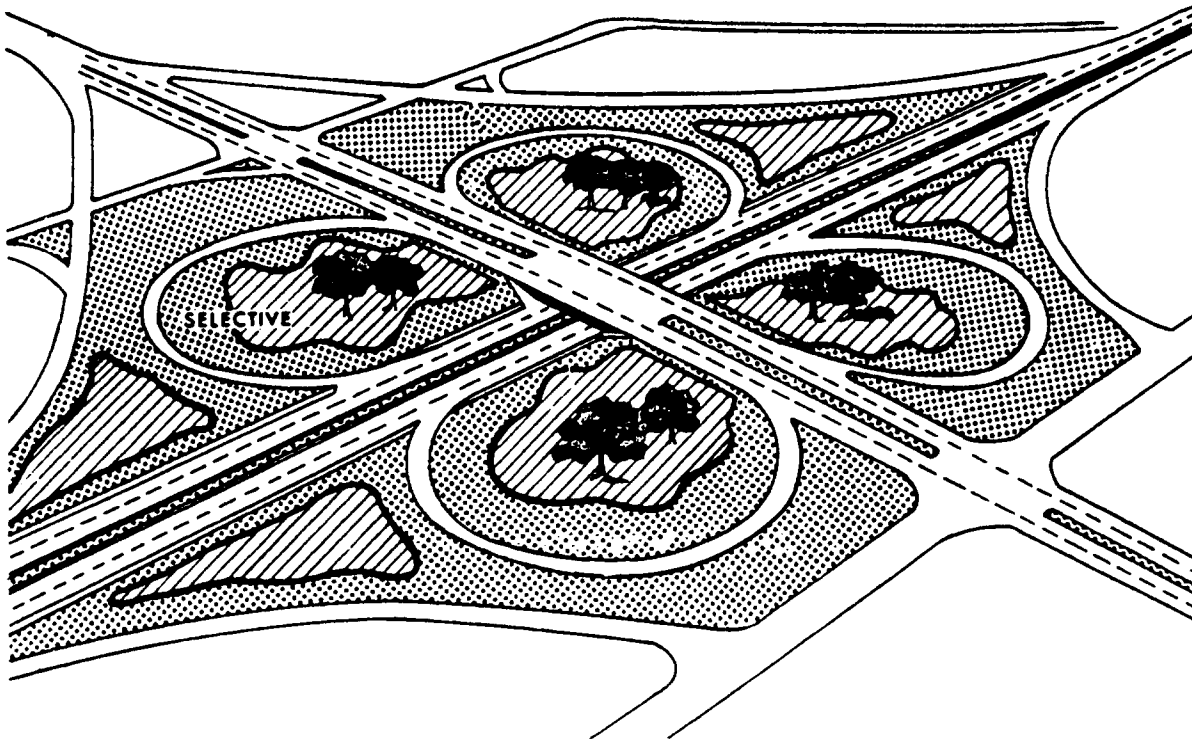
The relatively large areas encompassed by interchanges offer an excellent opportunity to define mowing limits and greatly reduce the usual mowed areas while maintaining more than adequate sight distance. Contour or selective mowing may be utilized in these areas to vary the outline of an unmowed area where no other feature dictates the mowing limits. Mowing limits are varied to achieve a natural appearance to reduce the area to be mowed.

The greatest savings in mowing can be accomplished in the area from the edge of the pavement to the right-of-way line; the appearance of the roadside can be improved with contour or selective mowing.



Safety mowing is the highest priority and will be performed as required to maintain growth at a height of less than 12 inches.

Normal mowing limits, as defined in the General Policy Statements, will be used except when adjacent land use requires additional width (Figure 2.9).



**Figure 2.8.** Selective Mowing At Interchange Sites.

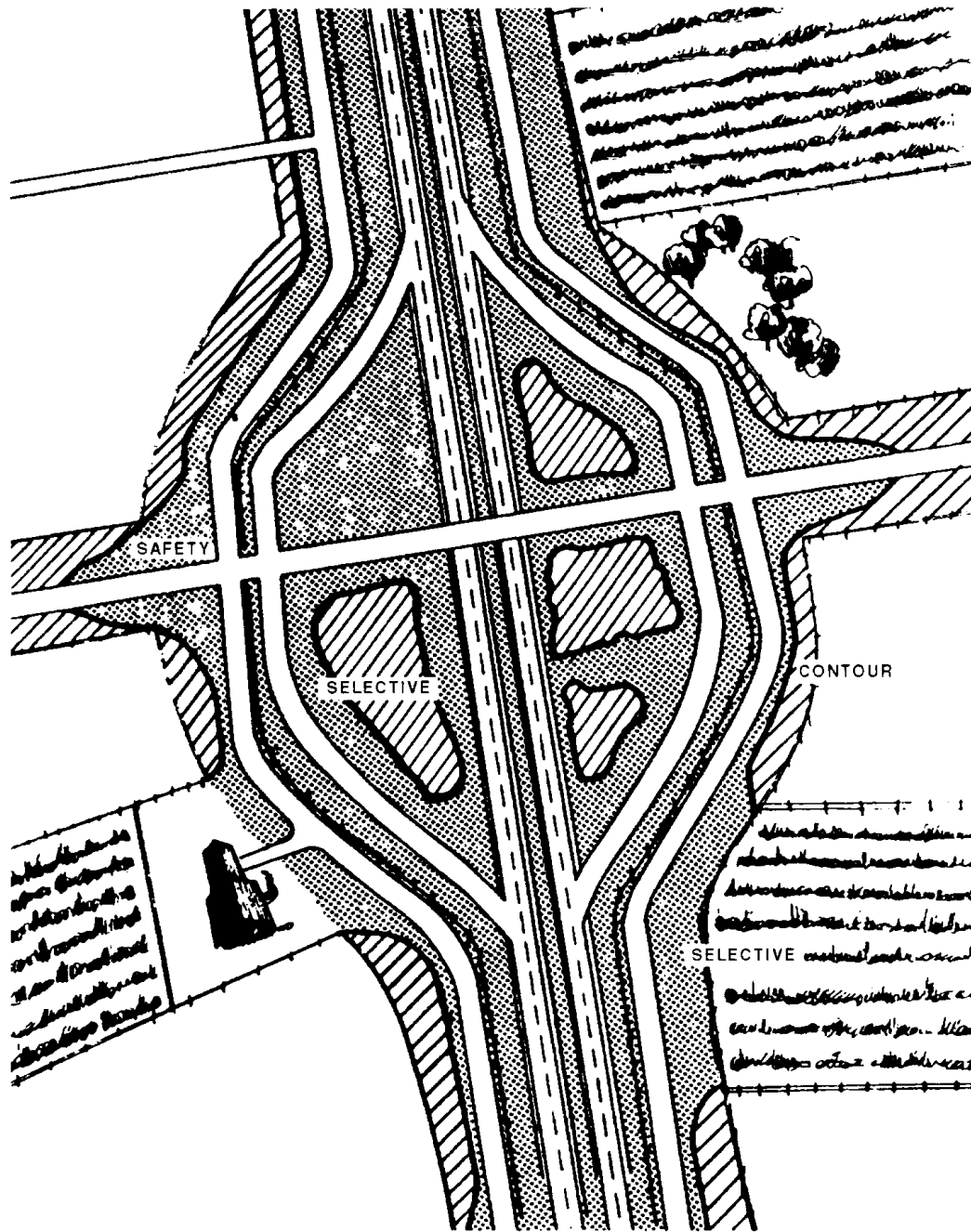


Figure 2.9. Safety, Selective And Contour Mowing At Multi-Lane Interchanges.

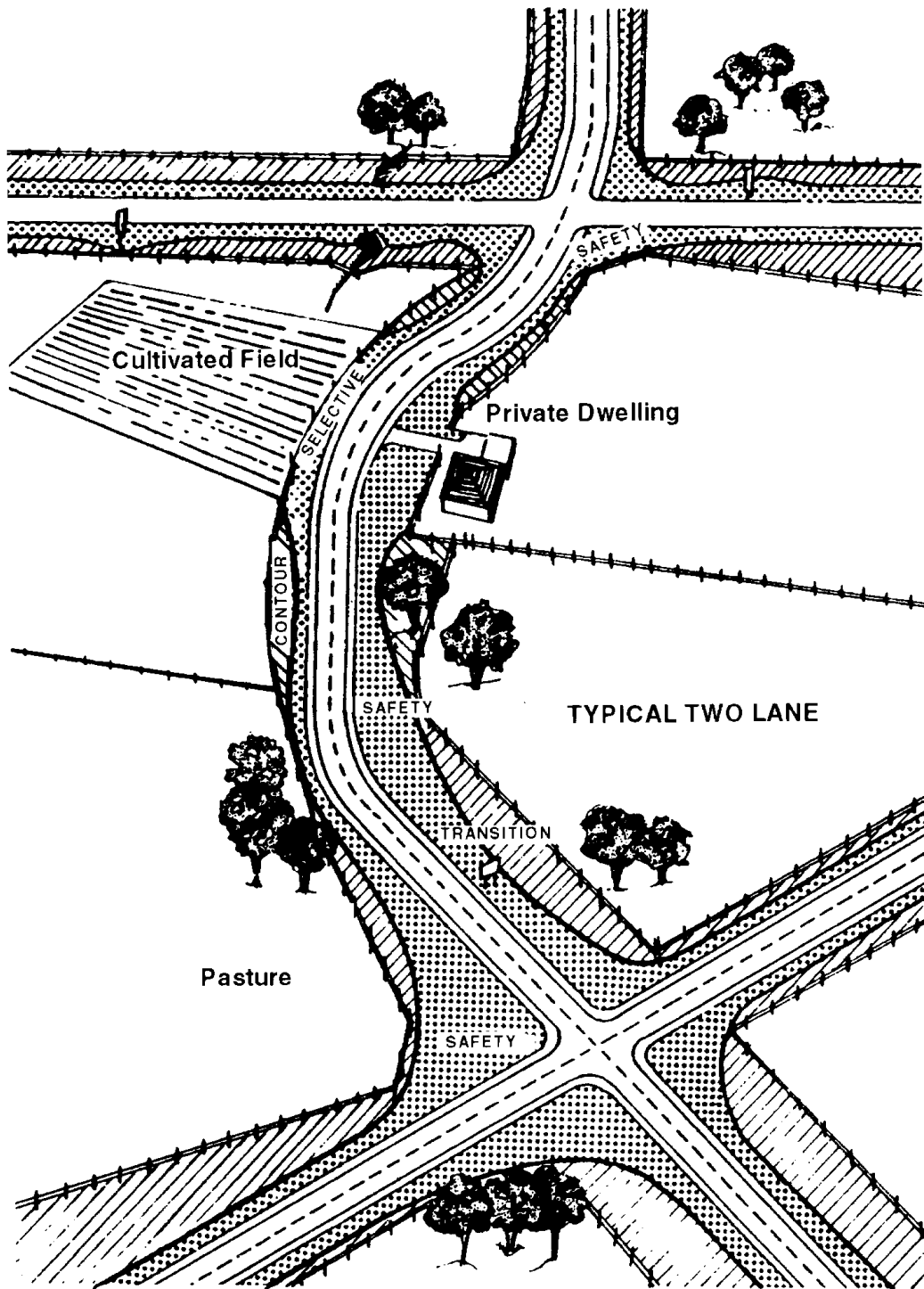
## **2.5 MOWING STANDARDS FOR TWO-LANE FACILITIES (RURAL)**

The CW 21-7 (36" x 36") warning sign will be used on all two-lane facilities. The sign will be placed approximately 750 feet in advance of the mowing operation. When the mowing operation could present a hazard for both sides of the highway, signs will be placed for both directions of traffic.

Safety mowing is the highest priority and will be performed as required to maintain growth at a height of less than 12 inches.

Normal mowing limits, as defined in the General Policy Statements, will be used except when adjacent land use requires additional width (Figure 2.10).

Where total right-of-way widths are 80 feet or less, mowing may be done from right-of-way to right-of-way line.



**Figure 2.10.** Safety, Contour, Selective And Transition Mowing On Rural Two-Lane Facilities.

## **2.6 MOWING STANDARDS FOR URBAN AND DEVELOPED AREAS ADJACENT TO CITIES AND TOWNS**

The CW 21-7 (36" x 36") warning sign will be placed approximately 250 feet in advance of the mowing operation (where speeds are lower) in urban and developed areas adjacent to cities and towns.

Urban areas will be mowed from right-of-way line to right-of-way line, except in those areas where it is feasible to reduce the limits due to the permissible field conditions, and areas where wildflower plots exist.

Where lawns, yards, parking lots, etc., extend to the highway rights-of-way, mowing will be done more often to maintain a "good neighbor" policy.

## **2.7 OPERATOR SAFETY**

1. Read and be familiar with tractor and mower operator's manuals.
2. Mower operators shall comply with the current ODOT Safety Manual and the Manual of Uniform Traffic Control Devices.
3. Be familiar with the hazards associated with mowing in herbicide treated areas.
4. Take special precautions to protect yourself from the sun.
5. Wear your seat belt at all times when operating.
6. Never bypass the safety start systems or remove any of the guards or safety devices.
7. Use hand signals to let others know your intentions.

### **CARE ABOUT SAFETY**

# **CHAPTER 3.0 INTEGRATING MOWING AND HERBICIDE PROGRAMS**

## **3.01 PURPOSE**

The purpose of this chapter is to provide information concerning factors that affect the success of mowing and chemical weed control programs so that roadside vegetation managers can effectively integrate these two practices and optimize their management program.

## **3.1 EFFECTS OF MOWING ON ROADSIDE PLANT GROWTH AND DEVELOPMENT**

The mowing of highway roadsides is an important practice in an integrated roadside vegetation management program. Mowing enhances the natural beauty of the roadside and improves highway safety by providing definition to areas beyond the travel corridor. Mowing may also aid in reducing or slowing the invasion of right-of-way areas by undesirable plant species. These undesirable plants are collectively called “weeds.” If properly timed, mowing will prevent or reduce the production of seed by certain weed species. However, its effectiveness in controlling weeds depends on several factors. Proper weed identification and knowledge of the weed’s life cycle are essential in improving mowing effectiveness. Unfortunately, mowing is a practice often performed when most convenient rather than when most effective for controlling weeds. Huffine et al. published in a previous report to ODOT (Roadside Development and Erosion

Control, Miscellaneous Publication, MP-93) a proposed schedule for mechanical (mowing) weed control (Table 3.1) along highway rights-of-way in Oklahoma. They suggested that mowing alone would not likely be a practical and economical weed control practice, but when judiciously used it could complement other weed control practices.

### **3.1.1 Annual Grasses and Broadleaf Weeds**

An annual weed (grass or broadleaf) reproduces only from seed and completes its life cycle in one year or less. Mowing is generally considered more effective on annual broadleaf weeds than on annual grassy weed species. This is due largely to the fact that most annual grasses tend to initiate new growth from basal meristems (growing points are located at the base of the plant – closer to ground level). This results in the annual grasses being able to withstand the mowing because the growing points are usually protected below the cutting height. On the other hand, annual broadleaf plants usually have exposed growing points at the tips of the shoots, all along the stem and in the leaf axils, all above the mowing level. As a result, broadleaf weeds are more severely injured by mowing, resulting in suppression of regrowth or control of the broadleaf weed. In areas occupied by annual weeds, mowing would be most effective at the end of the annual weed's growth cycle just prior to the setting of seed. If the seed heads of the annual weeds are removed prior to maturity, most of these plants will not be able to reseed, lessening reinvasion the following year. Since not all weed seeds in the soil germinate in a single year, previously dormant seed will remain available to germinate in subsequent years.

### **3.1.2 Biennial Broadleaf Weeds**

Similar to annual weeds, a biennial plant reproduces only from seed. However unlike annuals, it takes a biennial plant two years to complete its life cycle. During the first year it germinates from seed and grows vegetatively, producing a rosette and a fleshy taproot in which is stored food reserves for the following year. During the second year, it uses the food reserves stored in the taproot to grow vegetatively and produce a flower stalk and seed head. The seed produced will be next year's new generation of plants. One would normally think that mowing biennial broadleaf weeds once they begin flowering would be an effective method of control, similar to the mowing of annual broadleaf weeds. However, the authors have witnessed musk thistle regrowth following mowing of flowering plants. This was the result of the tractor tires traveling over the hollow-stemmed plants, partially crushing and breaking them over prior to cutting. As a result, some of the plants were mowed higher than desired, which allowed axillary buds located in the leaf axils to form new stems, flowers and eventually seeds in areas left undisturbed. Other research has indicated that musk thistle is able to produce seed on flowers removed by mowing if cut just four days after the flowers first opened.

Results from our research regarding control of Scotch thistle in Roger Mills County in Oklahoma indicate that some Scotch thistle plants are capable of withstanding two mowing cycles, continuing to grow and producing seed in a wet growing season. Based upon this information, it is more economical for ODOT to use an herbicide treatment rather than mowing to effectively control Scotch thistle and keep it from producing seed.



### **3.1.3 Perennial Broadleaf Weeds and Grasses**

A perennial weed, whether a broadleaf or grass, will live more than two years. Perennial weeds, by their very nature, are the most difficult to control and manage along highway roadsides in Oklahoma. They can reproduce vegetatively and by seed. Vegetative reproduction may occur from either stolons, rhizomes, tubers, bulbs or budding roots. Seed production by perennial weeds can be prevented or reduced by timely mowing; however, vegetative reproduction cannot be effectively controlled by mowing. Most perennial weeds should be mowed when flower buds begin to appear, or in the early bloom stage. This is usually the period in which the weed has the smallest amount of food reserves left in its roots. Repeated mowings at this stage of growth will gradually reduce food reserves, weaken regrowth and reduce competition with the desirable plant species. Control of this type requires timely mowing cycles and thus it is usually impractical for ODOT to implement. The effectiveness of mowing certain perennial weeds may be affected by their growth habit. Infestations of erect or taller-growing perennial weeds may be reduced or possibly even eliminated by timely repeated mowings until the root reserves are totally exhausted. On the other hand, mowing is usually ineffective against prostrate or lower growing perennial weeds such as field bindweed. Unfortunately, prostrate perennial weeds are often invaders of frequently mowed rights-of-way. Additionally, mowing the tops of certain perennial weeds destroys apical dominance causing dormant buds to start growing. This results in more stems on the weeds than were present prior to mowing. Concerning ODOT's current roadside vegetation management program, the practice of mowing perennial weeds along roadsides in an effort to control them is impractical. This is usually the

case unless ODOT integrates an herbicide application with mowing to obtain acceptable control of the targeted perennial weed problems.

#### **3.1.4 Bermudagrass and Other Desirable Grasses**

ODOT's primary objective in their current roadside vegetation management program is to promote the release of bermudagrass along roadsides, particularly immediately adjacent to the paved surface for 25 to 30 feet and in many instances extending to the drainage ditch. The remaining areas, including sloped areas, are usually managed to facilitate the growth of common bermudagrass, desirable native grasses and/or weeping lovegrass.

Bermudagrass is usually very tolerant to the number of annual mowings performed by ODOT. This number may vary from as few as 1 to 5 or more, depending on specific sites, such as rural areas, interstates or on urban rights-of-way. In many instances, the decision to mow a particular bermudagrass right-of-way is not based primarily on achieving weed control. Instead, a roadside area is often mowed to improve the overall aesthetics of the site by improving traits such as smoothness and uniformity. As a result, a mowing will not usually aid in the control of undesirable weed species, but will instead temporarily suppress weeds, allowing regrowth and continual competition with the desirable bermudagrass. This fact makes the use of selective herbicide treatments an integral part of ODOT's overall roadside vegetation management program in controlling undesirable weeds and promoting the growth of bermudagrass.

To maintain and encourage healthy stands of native and introduced grasses such as weeping lovegrass on backslopes (including cut and fill slopes), the practice of mowing is discouraged. In support of this comment, Huffine et al. in Publication MP-93 recommended to ODOT “Do not mow cut and fill slopes.” They observed that frequent and improper low-mowing of slow-growing, bunch-type tallgrasses such as little and big bluestem, Indiangrass, switchgrass and weeping lovegrass reduced the depth of root penetration proportional to the shortened tops. This practice prevented a buildup of stored foods by the grasses, which would have enabled them to resist the low temperatures of winter and the hot, dry conditions of summer. Previous research conducted in Oklahoma during 1963 showed that the density of nativegrass stands and plant vigor decreased, and broadleaf weeds and annual brome competition increased under increased frequency of clipping. Huffine et al. also observed and published that “the operation of mowers on highly erosive cut and fill slopes is one of the most destructive practices imposed on the protective grass cover. The vegetative cover is not only destroyed by the improper practice of mowing too short and too frequently, but also by plants being physically torn from the soil by the shearing action of the tractor sliding as it attempts to traverse the slope, or from the spinning wheels in ascending the steep slopes, or as they slide in attempt to stop or turn as they descend.” Other states including Colorado, in their mowing guidelines state “avoid mowing steep slopes. Mowing steep slopes (even in urban areas) increases (soil) compaction, causes slope failure and rutting, and decreases the vigor of the vegetation. Loss of plant growth results in slope erosion.” To maintain, promote and encourage the growth of native and

other desirable grasses on sloped areas, the practice of mowing should be limited, and conducted in most instances, only to control or discourage tree and brush growth.

### **3.1.5 Native and Planted Wildflowers**

Many of Oklahoma's roadsides are blessed with an abundance of wildflowers, both native/natural and introduced or planted. It is estimated that Oklahoma has approximately 4,000 different species of wildflowers; however, many of them are not adapted for roadside situations. To promote the preservation and planting of wildflowers along roadside areas, ODOT initiated a Roadside Wildflower Program in 1974. A major objective of that program was to delay roadside mowing in the spring and early summer to allow native wildflowers an opportunity to flower, set seed and spread. Since that time, ODOT has adopted a policy, written in its "Mowing Guide", outlining procedures for "Mowing Wildflower Areas." This information is discussed in this manual in Chapter 2, Section 2.3.3.

**Table 3.1.** Proposed Mowing Schedule for Mechanical (Mowing) Weed Control.

Common Names Scientific Names	Duration	Mowing Dates <sup>1</sup>						Method of Propagation	Division Infested
		April	May	June	July	Aug.	Sept		
Dogbane <i>Apocynum cannabinum</i>	perennial			X	X	X	X	Seeds, roots, or rhizomes	all
Stiff Goldenrod <i>Solidago rigida</i>	perennial				X	X	X	Seeds	all
Common Ragweed <i>Ambrosia elatior</i>	annual				X	X	X	Seeds	all
Giant Ragweed <i>Ambrosia trifida</i>	annual				X	X	X	Seeds	all
Ironweed <i>Vernonia baldwinii</i>	perennial				X	X	X	Seeds	all
Tall Ironweed <i>Vernonia altissima</i>	perennial				X	X	X	Seeds	all
Rough Buttonweed <i>Diodia teres</i>	annual				X	X	X	Seeds	all
Velvetleaf <i>Abutilon theophrasti</i>	annual				X	X	X	Seeds	all
Flower-of-the-Hour <i>Hibiscus trionum</i>	annual				X	X	X	Seeds	all
Russian Thistle <i>Salsola kali</i>	annual				X	X	X	Seeds	3, 4, 5, 6, 7
Cocklebur <i>Xanthium pennsylvanicum</i>	annual				X	X	X	Seeds	all
Prickly Lettuce <i>Lactuca scariola</i>	annual or winter annual				X	X	X	Seeds	all

<sup>1</sup>These correspond essentially with flowering dates.

**Table 3.1.** Continued.

Common Names Scientific Names	Duration	Mowing Dates						Method of Propagation	Division Infested
		April	May	June	July	Aug.	Sept		
Woolly Plantain <i>Plantago purshii</i>	annual	X	X	X				Seeds	all
Western Ragweed <i>Ambrosia psilostachya</i>	perennial			X	X	X	X	Seeds	all
Snow-on-the Mountain <i>Euphorbia marginata</i>	annual				X	X	X	Seeds	all
Blackeyed Susan <i>Rudbeckia hirta</i>	perennial		X	X	X	X		Seeds	all
Russian Knapweed <i>Centaurea repens</i>	perennial			X	X	X		Seeds and roots	6
Curled Dock <i>Rumex crispus</i>	perennial			X	X	X	X	Seeds	all
Sand Sunflower or Plains Sunflower <i>Helianthus petiolaris</i>	annual			X	X	X	X	Seeds	all
Mare's Tail or Horseweed <i>Erigeron Canadensis</i>	annual			X	X	X	X	Seeds	all
Prickly Poppy <i>Argemons intermedia</i>	annual		X	X	X	X	X	Seeds	all
Wild Blue Lettuce or Perennial Lettuce <i>Lactuca pulchella</i>	perennial			X	X	X		Seeds and creeping roots	6
Rugel or Blackseed Plantain <i>Plantago rugelii</i>	perennial			X	X	X	X	Seeds	1, 2, 3, 4, 8
Stinging Nettle <i>Urtica dioica</i> <i>ssp. Dioica</i>	perennial			X	X	X	X	Seeds under- ground rootstock	or 1, 2, 3, 4, 8

**Table 3.1.** Continued.

Common Names Scientific Names	Duration	Mowing Dates						Method of Propagation	Division Infested
		April	May	June	July	Aug.	Sept		
Rough Pigweed <i>Amaranthus retroflexus</i>	annual			X	X	X	X	Seeds	all
Lamb's Quarters <i>Chenopodium album</i>	annual		X	X	X	X	X	Seeds	all
Bracted Plantain <i>Plantago aristata</i>	annual or winter annual			X	X	X	X	Seeds	1, 2, 3, 4, 7, 8
Horsenettle <i>Solanum carolinense</i>	perennial		X	X	X	X	X	Seeds	all
Prickly Pear <i>Opuntia species</i>	perennial		X	X	X			Seeds stems	and all
Fleabane or Daisy Fleabane <i>Erigeron strigosus</i>	annual or biennial winter annual	X	X	X	X			Seeds	all
Buckhorn Plantain <i>Plantago lanceolata</i>	perennial		X	X	X	X	X	Seeds	8
Ground Cherry <i>Phsalia heterophylla</i>	perennial		X	X	X	X		Seeds	all
Silverleaf Nightshade <i>Solanum elaeagnifolium</i>	perennial		X	X	X	X		Seeds	all
Buffalo Bur <i>Solanum rostratum</i>	annual			X	X	X		Seeds	all
Peppergrass <i>Lepidium virginianum</i>	annual or winter annual	X	X	X	X			Seeds	all

**Table 3.1.** Continued.

Common Names Scientific Names	Duration	Mowing Dates						Method of Propagation	Division Infested
		April	May	June	July	Aug.	Sept.		
Wild Pumpkin or Wild Gourd <i>Cucurbita foetidissima</i>	perennial		X	X	X	X	X		4, 5, 6, 7
Prickly Sida <i>Sida spinosa</i>	annual		X	X	X	X	X	Seeds	1, 2, 3, 4, 8
Carolina Cranesbill <i>Geranium carolinianum</i>	annual	X	X					Seeds	all
Evening Primrose <i>Oenothera spp.</i>	perennial	X	X					Seeds	all
Curlycup Gumweed <i>Grindelia squarrosa</i>	biennial		X	X				Seeds	all
Western Yarrow <i>Achillea lanulosa</i>	perennial			X	X	X	X	Seeds and underground rootstocks	all
Mullen <i>Verbascum thapsus</i>	biennial			X	X	X	X	Seeds	1, 8
Prairie Rose <i>Rosa suffulta</i>	perennial			X	X	X		Seeds and underground roots	8
Woolly Croton <i>Croton capitatus</i>	annual				X	X	X	Seeds	all
Field Thistle or Tall Thistle <i>Cirsium altissimum</i>	perennial			X	X	X	X	Seeds	1, 2, 4, 5, 6
Kochia, Burning Bush or Mexican Fireweed <i>Kochia scoparia</i>	annual			X	X	X	X	Seeds	5, 6, 4, 8



**Table 3.1.** Continued.

Common Names Scientific Names	Duration	Mowing Dates						Method of Propagation	Division Infested
		April	May	June	July	Aug.	Sept		
Salt Bush or Orache <i>Atriplex patula</i>	annual				X	X		Seeds	4, 5, 6
Spiny Pigweed <i>Amaranthus spinosus</i>	annual				X	X	X	Seeds	all
Pennsylvania Smartweed <i>Polygonum pennsylvanicum</i>	annual			X	X	X	X	Seeds	all
Wild Sunflower <i>Helianthus annuus</i>	annual			X	X	X	X	Seeds	all
Erect Knotweed <i>Polygonum erectum</i>	annual			X	X	X	X	Seeds	all
Yellow Sweet Clover <i>Melilotus officinalis</i>	biennial		X	X	X	X		Seeds	all
White Sweet Clover <i>Melilotus alba</i>	biennial		X	X	X	X		Seeds	all
Jerusalem Artichoke <i>Helianthus tuberosus</i>	perennial					X	X	Seeds, rhizomes and tuber	1, 2, 3, 4, 8
Thoroughwort <i>Eupatorium altissimum</i>	perennial					X	X	Seeds	1, 2, 3, 4, 7, 8
Johnsongrass <i>Sorghum halepense</i>	perennial		X	X	X	X	X	Seeds and rhizomes	all
Musk Thistle <i>Carduus nutans</i>	biennial		X	X	X	X		Seeds	all
Scotch Thistle <i>Onopordum acanthium</i>	biennial		X	X	X	X		Seeds	5, 6
Silver Bluestem <i>Bothriochloa laguroides</i>	perennial			X	X	X	X	Seeds and crown buds	all
Switchgrass <i>Panicum virgatum</i>	perennial			X	X	X	X	Seeds and rhizomes	all

## **3.2 EFFECTS OF MOWING ON HERBICIDE EFFICACY**

The influence of mowing on an herbicide's ability to produce the desired weed control effect (herbicide efficacy) should be considered in an herbicide program. Mowing needs to be coordinated around the spraying program to ensure the effect of the herbicide is maximized.

### **3.2.1 Contact Herbicides**

Contact herbicides are those herbicides used to defoliate and/or desiccate targeted weed species. Mowing and contact herbicides produce similar results; they temporarily suppress the tall growing foliage to an acceptable height. Therefore, mowing within 14-28 days after application of a contact herbicide should not be needed. If the combination of a contact herbicide (such as MSMA) and untimely mowing is used, there will be a waste of time and money for ODOT. In an MSMA program where multiple applications are needed for control of the weed species, a timely mowing could replace a timely spray application.

### **3.2.2 Translocated Herbicides**

Translocated herbicides are those herbicides which are applied to the foliage of plants so that they can be absorbed into the leaf surface and moved throughout the plant. Glyphosate is an example of a translocated herbicide. For this reason, translocated herbicides need sufficient time to reach all parts of the plant, including the roots before mowing (Table 3.2). If plants treated with translocated herbicides are mowed pre-maturely, the plant parts containing the herbicide could be removed before

the plant has had the opportunity to completely translocate the herbicide throughout the entire plant. This could reduce efficacy while increasing the amount of regrowth from the targeted weed species. Refer to the herbicide label and to Table 3.2 for recommendations regarding the appropriate interval between herbicide application and the first post-treatment mowing.

### **3.2.3 Residual Herbicides**

Residual herbicides are applied to weeds and soil. Rainfall is needed to wash the herbicide off the plant foliage into the soil. Once in the soil, the herbicide is then absorbed by the roots or shoots of susceptible plants and translocated upward throughout the plant. Since residual herbicides are absorbed primarily through the roots, mowing is not as critical on this type of application as with foliar translocated products.

It is possible that windy, wet weather or even drought could prevent timely summer herbicide applications. In these situations it may be necessary to mow roadsides in May before herbicide applications are applied to control johnsongrass and other summer weeds. This mowing will delay or could even prevent the application of glyphosate + Oust, Outrider, or Plateau treatments, while having little effect on MSMA programs. Once roadsides have been mowed prior to treatment, it would be important to delay future herbicide treatments until regrowth is acceptable (Table 3.2). Applying a translocated treatment such as glyphosate + Oust soon after a mowing will result in reduced johnsongrass control as critical leaf area is removed and no longer available to absorb the herbicide.

Communication between the parties responsible for mowing and herbicide application is critical to ensure the best results for both programs.

**Table 3.2.** Commonly used herbicides and appropriate mowing and treatment intervals.

Residual/Translocated Herbicides	Recommended Time Between Application and Mowing	Recommended Time After Mowing Before Herbicide Application
imazapyr (Arsenal)	28 days	6-12 inches regrowth
Metsulfuron methyl (Escort)	7-14 days	6-10 inches regrowth
Hyvar	28 days	immediately
diuron	7-14 days	not applicable
Milestone VM	28 days	immediately
sulfometuron (Oust)	7-14 days	12-18 inches regrowth
Outrider	7-14 days	18 inches regrowth
Plateau	7-14 days	12-18 inches regrowth
Sahara	28 days	6-12 inches regrowth
Tordon K	28 days	immediately
<b>Contact Herbicides</b>		
MSMA (generic)	21-28 days	12-24 inches
Krenite	do not remove brush until the following spring	following growing season
<b>Translocated Herbicides</b>		
Banvel	28 days	6-10 inches regrowth
Campaign	7-14 days	not applicable
Overdrive	28 days	6 inches regrowth
Garlon 4 Ultra	28 days	6-10 inches regrowth
glyphosate (aquatic)	7-14 days	not applicable
glyphosate	7-14 days	12-18 inches regrowth
Transline	28 days	6-10 inches regrowth
Vanquish	28 days	6-10 inches regrowth

### **3.3 Prioritizing Mowing and Herbicide Practices**

ODOT maintenance personnel invest a significant portion of their time and effort each year in mowing and herbicide applications. It is vitally important that each level of ODOT personnel realize that the priorities placed on conducting the mowing and herbicide applications in a timely manner will ultimately dictate the long-term benefits gained from these efforts. If mowing and herbicide programs are to have their greatest impact, ODOT roadside vegetation managers must remember the importance of prioritizing these roadside programs amongst the many internal and external influences.

#### **3.3.1 Factors Influencing Prioritization**

There are a number of factors that can influence the priority level placed on both mowing and herbicide application practices. Many of these factors which do not originate within ODOT can create difficult vegetation management situations. It is much easier to prioritize ODOT goals to meet ODOT objectives than it is to implement outside priorities which may or may not share the same goals. Nevertheless, prioritization of mowing and herbicide practices with the many other maintenance activities is required to achieve success.

##### **3.3.1.1 ODOT Statewide Goals and Objectives**

It is a goal of ODOT that all roadsides shall primarily consist of low-growing, sod-forming, perennial grasses that will provide for the maximum level of erosion protection. Preferred species of grass include common bermudagrass; buffalograss; blue, black, hairy, and sideoats grama; and even tall fescue in extreme eastern and northeastern

Oklahoma. These grasses will be selected for by using all available management tools. Both in-house and contracted mowing and herbicide applications can be used to promote the growth and development of roadside grasses.

Mowing guidelines, as addressed in Chapter 2, shall be followed as closely as possible by all state maintenance forces. Vegetation heights should be maintained between 6 and 12 inches in Safety Areas unless integrated programs require otherwise. To assist in maintaining vegetation heights within guidelines, a selective herbicide program should be integrated to control or manage tall growing weeds. Special attention should be given to the control of designated noxious weeds.

In 1989 the Department entered into an agreement with the Oklahoma Department of Wildlife Conservation to recognize roadsides as being a viable site for ground nesting birds to raise their young. In an effort to increase quality nesting habitat, the Department agreed to manage certain roadside areas to minimize negative impacts on quail, pheasant, and other ground nesting birds. The memorandum (Figure 3.1) provides for delays in mowing as well as “No Mow” areas that are located outside of Safety Areas. Herbicide applications will also be minimized in these same areas.

### **3.3.1.2 ODOT Field Division Goals and Objectives**

While the field divisions should share statewide Departmental goals, it is likely that their goals may be more specific in detail to accommodate everything from the local public attitudes to the individuality of the roadside plant community.

Oklahoma is a very diverse state with a large percentage of its population living in the urban areas of Oklahoma City and Tulsa. Public attitudes may vary considerably between urban and rural areas. In general, the public in rural areas is more understanding of the processes used in managing roadsides because of their closer ties and knowledge of agriculture. Therefore, roadside management levels may be somewhat lower in rural areas while still remaining acceptable. An unkempt appearance on a roadside in an urban area is viewed daily by thousands of people, many of which expect to see something along the lines of a park and not a roadside. Urban roadsides, besides being more dangerous to maintain, will require higher levels of both mowing and selective herbicide use in order to be acceptable.

The different plant communities found along Oklahoma roadsides also will impact goals set at the Division level. In western Oklahoma, because of lower rainfall levels and shorter plant species, the level of maintenance should be adjusted accordingly. In these more arid portions of the state, native species such as buffalograss, blue and hairy grama, and native wildflowers become a much more important component of the roadside plant community. These plants thrive under the growing conditions in western Oklahoma while requiring less mowing to maintain acceptable heights. In these areas it will still be important to control invasive weedy species, however, lower herbicide rates can often be used in western Oklahoma. In central Oklahoma, native short grass

species give way to the tall grass species of switchgrass, Indiangrass and bluestems. While very desirable for fill and cut slopes, these species should be controlled when they encroach into the Clear Zone or Safety Areas. If a native species is targeted for control, it will require an adjustment in roadside vegetation management programs. Not only will switchgrass management require special herbicide treatments, it also requires an integrated mowing program to ensure actual control. In the eastern portion of the state one not only gets increased rainfall, but intermixes of common bermudagrass (warm-season grass) and tall fescue (cool-season grass) are more common. Intermixes lengthen the window of roadside vegetation maintenance as cool-season grasses continue growth much later into the fall and resume growth earlier in the spring than warm-season grasses such as bermudagrass. This usually requires additional mowings to maintain acceptable height on roadside vegetation. It is best to promote either bermudagrass or tall fescue and remove the less desirable grass. This simplifies objectives and maintenance programs.

### **3.3.1.3 Political Influences**

State legislators throughout Oklahoma carry a lot of pride to and from their respective districts. Pride is levied during times of appropriations at the state capitol. During their travels within their districts, it is important that legislators feel that both roadways and roadsides are being managed as efficiently and effectively as possible. A roadside which is not under a quality integrated roadside vegetation management program will likely look very poor during much of the growing season. This could reflect badly not only on ODOT but on the local state legislators. It is not uncommon for



legislators to contact maintenance personnel directly requesting some type of roadside vegetation maintenance. If the road in question is in need of maintenance, hopefully the scheduled program can be moved up. However, if the roadside in question complies with ODOT vegetation height guidelines, the legislator should be informed of the RVM program. If a successful RVM program is in place, calls of this nature should be few and far between and deviation from a successful program is not usually an economical or efficient use of roadside funds.

#### **3.3.1.4 County, Municipal, and Other Influences**

Many entities have an influence over current ODOT mowing and herbicide programs. By policy, ODOT is to mow all state highways up to the city limits of all towns of a population of 3,000 or more. Towns with a population less than 3,000 should be maintained “as needed” throughout the city limits. Often city representatives will contact ODOT to modify these policies to enhance the roadsides entering or leaving their city or town. Requests could be made regarding additional mowing, herbicide applications or other maintenance work and these practices are usually performed at the discretion of ODOT county maintenance personnel. Each and every private landowner in Oklahoma may potentially influence mowing and herbicide programs by either contacting ODOT or their state legislator directly with suggestions or complaints. To keep influences such as these to a minimum, a properly managed RVM program should be employed and seasonal priorities should be met.

### **3.3.2 Communication of Mowing and Herbicide Program Priorities**

Considering the many levels of ODOT personnel who influence mowing and herbicide programs as well as the external influences of other entities, clear communication of priorities is essential. It is as important to identify and communicate those program components that will not be supported as they are not part of a quality RVM program. To achieve the maximum benefit from a mowing and/or herbicide application, it is crucial that each of these practices receive priority during their short but important time of optimum application. Each of these two components depends upon the other for maximum effect. Random scheduling during the growing season will yield only temporary benefits. Timely scheduling of broadcast herbicide treatments followed by safety and contour mowing practices require constant communication between field division, county superintendents and county maintenance workers. Communication of program specifics and priorities create the level of support of which all good RVM programs are made. Maintenance personnel have ample opportunities each year to set and/or modify both state and divisional goals and priorities with respect to both mowing and herbicide programs. ODOT personnel are encouraged to consult the OSU RVM team for assistance in prioritizing roadside vegetation management activities.

## **3.4 PRECAUTIONS IN INTEGRATING MOWING AND HERBICIDE PROGRAMS**

The following are a few key points of importance when integrating mowing and herbicide programs.

### **3.4.1 Maximizing the Effects of Mowing**

Most roadside managers are aware that mowing is, for the most part, a quick but temporary solution to roadside vegetation management. Mowing will continue to be very important in managing the very diverse plant communities found along the roadside. However, in these modern days of integrated roadside vegetation management programs, the cure for a roadside with tall vegetation may or may not be mowing. To maximize the quality and duration of mowing effects, mowing should be coordinated specifically with the herbicide program. After all, the objective of the herbicide program is to control or manage tall-growing, weedy plants that are likely responsible for the need to mow. Controlling winter annual grasses and broadleaf weeds should eliminate the need for spring mowing. With the safety areas greening up relatively weed free, the summer weeds eventually begin to grow and are ready for herbicide treatments in May or early June each year. It is at this point that managers may look to mowing instead of herbicides. Mowing prior to the summer herbicide applications will usually reduce their effectiveness by changing application timings and development stage of targeted plants. To maximize the effects from the first mowing each year, it should be scheduled to begin approximately 10-14 days (see Table 3.2) after herbicide applications are completed in early summer. This timing will give the herbicide a chance to translocate within targeted plants while removing the unsightly browned-off top growth. At this point the desirable grass understory should continue to develop.

### **3.4.2 Herbicide Exposures During Mowing Applications**

Employee exposure to any pesticide is a concern to ODOT. Whenever and however possible, exposures should be kept to a minimum. Following the application of all herbicides, there will be a residue left either on or in the plants and soil. The amount of time that it takes to break down the residue varies from herbicide to herbicide. During mowing applications it is very possible for the operator to become exposed to a small amount of these residues. To minimize these low level exposures, mower operators should at a minimum allow the herbicide spray to dry on the surface of the soil or treated plant before mowing. If a mowing did occur soon after an herbicide application had dried on plant surfaces there would be very little herbicide transfer from mowed vegetation to bare skin. Keep in mind that mowing this soon after most herbicide applications should not be a routine practice as this untimely mowing will reduce weed control. If possible, it would also be beneficial to wait until after a rainfall has occurred before mowing areas treated with herbicides. The rainfall will wash the herbicide into the soil for activation and help remove residues left on the surface of leaves and stems. The herbicide exposure received during mowing operations should not be a major concern of ODOT employees as long as they follow these simple suggestions and ODOT continues to use herbicides which have good safety profiles.

### **3.4.3 Contract Mowing and/or Herbicide Programs**

Starting in the early 1990s ODOT, along with most other state DOTs, began downsizing. This ultimately resulted in privatizing some roadside maintenance activities. In recent years, contract mowing occurs to some degree in most field

divisions while contract herbicide applications have been much slower to develop. It is important to remember that whether in-house or contracted, both mowing and herbicide programs should still be conducted using sound RVM practices. If contracted, mowing guidelines should be incorporated into contracts in such a manner that contractors are aware of in-house herbicide application and weed control programs so that mowing can be scheduled appropriately. With good communication between ODOT and contractors, untimely mowing can be avoided. Contracted herbicide applications also require well written contracts to assure that ODOT objectives are met. Herbicides, rates, and timing of applications are critical to achieve desired results from a contractor's application. It is just as important that in-house mowing programs are used to complement the contracted spray efforts.

Even though ODOT crew sizes are slowly increasing they remain smaller in size than those of the late 1980s. Consequently, contract mowing will likely remain an important component of ODOT RVM programs. A contractor who is aware of ODOT RVM objectives will be much more likely to deliver the desired results. Communication of these basic objectives will be important so that contractors can schedule their efforts to compliment ODOT herbicide applications for weed control.

**Figure 3.1.** Excerpted Memorandum Of Understanding Between Oklahoma Department Of Wildlife Conservation And Oklahoma Department Of Transportation (below).

WHEREAS, the Oklahoma Department of Wildlife Conservation is charged with the management of the State's Wildlife resources, habitats and recreation derived there from and,

Whereas, such management is based on habitat development and improvement and,

Whereas, the Oklahoma Department of Transportation owns and maintains 138,174 mowable acres of public land in the rights-of-way of State highways and,

Whereas, the Oklahoma Department of Transportation is charged with design, construction, maintenance, human safety and vegetation management within such rights-of-way and,

Whereas, quality vegetative cover in rights-of-way can significantly increase nesting habitat for quail, pheasant and other ground nesting birds and,

Whereas, the Oklahoma Department of Wildlife Conservation and Oklahoma Department of Transportation are each desirous of performing their responsibilities in an efficient and economical manner, in concert with each other and in the best interests of the citizens of Oklahoma.

Now, Therefore, in consideration of the execution and adoption of this agreement by the parties thereto, each one agrees with the other as follows:

1. Roadside mowing is a required vegetation management tool to maintain necessary aesthetics, safety and drainage requirements associated with state highways;
2. The Oklahoma Department of Transportation Mowing Guide is recognized as a useful standard for mowing operations and adherence thereto will be encouraged;
3. All "Safety Mowing" as defined by the Mowing Guide and other vegetation control within the area from the pavement to the drainage ditch shall be considered highest priority over any other conditions of this agreement;
4. Mowing outside the safety areas shall be delayed until August 1 of each year to promote successful hatching of ground nesting birds, unless adjacent land use dictates otherwise, or within urban areas where more intensive mowing is required.
5. Wherever possible mowing outside the safety areas will be discontinued or accomplished every third year;
6. The Oklahoma Department of Wildlife Conservation will provide native grass or legume seed for new or reconditioned rights-of-way as available funds will permit, to promote quality nesting habitat;

**Figure 3.1.** Memorandum Of Understanding Between the ODWC and ODOT  
(Continued).

7. Herbicide use will be limited to safety areas unless required for control of noxious weeds or undesirable woody encroachment. The Oklahoma Department of Agriculture guidelines will be followed during ground application of herbicides to ensure that only the target area is treated;
8. The Oklahoma Department of Wildlife Conservation will utilize its information and education capabilities to inform the public of the importance of deferred mowing of highway rights-of-way to the wildlife resources of Oklahoma;
9. The Oklahoma Department of Transportation and Oklahoma Department of Wildlife Conservation will develop a program to promote living snow fences on private property adjacent to highway rights-of-way, to further improve both safety conditions and habitat quality;
10. The effectiveness of this habitat management program will be monitored in Oklahoma Department of Transportation's Division 6 in northwestern Oklahoma and the Panhandle, to determine appropriate modifications or further enhancements to the program;
11. Nothing contained herein shall be constructed as obligating either agency to expend any sum in excess of funds made available for such use;
12. It is recognized that the entire roadside may be available for haying when a drought emergency is declared by the Governor of Oklahoma;

This understanding shall remain in force until terminated by either Department or mutually modified.

This understanding is executed by the Oklahoma Department of Transportation Commission and Oklahoma Department of Wildlife Conservation Commission after due consideration on the dates affixed beside their authorization and adoption thereof.

In witness thereof, the parties hereto have signed this Memorandum of Understanding this 26<sup>th</sup> day of July, 1989.

OKLAHOMA DEPARTMENT  
OF  
WILDLIFE CONSERVATION

  
Carl Pierceall, Chairman

Oklahoma Department of Wildlife  
Conservation Commission

  
Director

OKLAHOMA DEPARTMENT  
OF  
TRANSPORTATION

  
Chairman

Oklahoma Department of  
Transportation Commission

  
Director

# CHAPTER 4.0 HERBICIDES

## 4.01 PURPOSE

The purpose of this chapter is to provide the reader with a basic understanding of herbicide classification; factors that affect herbicide behavior in the plant and in the environment; and ODOT and state policies/laws affecting the pesticide applicator.

## 4.1 INTRODUCTION

Herbicides are chemicals which either kill plants or inhibit their normal growth and development. Their use is the most recent technique for managing right-of-way vegetation. This practice has become an integral part of the ODOT's current roadside vegetation management program. Herbicides may be used to selectively control undesirable species of weeds while leaving desirable plants such as bermudagrass unharmed. Eliminating the competition from undesirable weeds promotes the growth of beneficial species and allows them to create an erosion resistant ground cover. Using herbicides has numerous other benefits as well in managing rights-of-way vegetation. Some of these include providing for a safe sight-distance near intersections and along curves by controlling tall growing species of undesirable weeds such as johnsongrass. Additionally, they provide for a more beautiful, aesthetically pleasing roadside.

The use of herbicides has proven to be an economical and effective method of managing rights-of-way vegetation. Using herbicides is one of several management techniques which can be incorporated into a quality roadside vegetation management program.



## **4.2 CLASSIFICATION OF HERBICIDES**

An understanding of the classification of herbicide behavior is essential to understanding how herbicides work and how to use them safely and effectively. Herbicide classification and modes of action can be found in Tables 4.1 and 4.2, respectively.

### **4.2.1 Nonselective Herbicides**

By definition, a nonselective herbicide is generally toxic to all plants and will control nearly all types of vegetation. They are usually applied either to the soil or to weed foliage (leaves) where a bareground effect is needed or where total vegetation control is required.

### **4.2.2 Selective Herbicides**

By definition, a selective herbicide is used to control or remove specific undesirable weed species from existing stands of desirable vegetation. Depending on the herbicide, the application can be made either to the soil or the foliage. Some of the brush herbicides may be applied to the bark around the base of the tree or to cut surfaces in the bark. Identification of the undesirable weed or brush species is the key in choosing the best herbicide and application method for control.

### **4.2.3 Types of Nonselective and Selective Herbicides**

Nonselective and selective herbicides may be classified into three different categories: (1) contact, (2) translocated, and (3) residual (see Table 4.1).

#### **4.2.4 Contact Herbicides**

By definition, contact herbicides are applied to the plant foliage (foliar-applied) and only kill the plant tissue that they contact (Table 4.1). They are used primarily to defoliate and desiccate plants to eliminate weed growth above ground. Excellent, uniform spray coverage of the targeted plants is essential to provide acceptable control of the target weeds. Most annual or biennial plants may be controlled with these types of herbicides; however, many perennial plants can re-sprout from untreated growing points protected below the soil surface. If an untimely rainfall or mowing event should occur shortly after the application of a contact herbicide, the effectiveness may be reduced.

#### **4.2.5 Translocated Herbicides**

By definition, a translocated herbicide is applied to the targeted plant foliage (foliar-applied) where it is absorbed from the leaf surface into the leaf cells. The herbicide is then translocated or moved to other growing points throughout the plant, sometimes including downward into the root system. Translocated herbicides are often referred to as systemic herbicides as well. Although translocated herbicides are effective in controlling most types of weeds, they are particularly effective in controlling established perennial weeds. Uniform coverage, while important, is not as critical as with contact herbicides. The effectiveness of a foliar-applied, translocated herbicide will be reduced if rainfall or mowing occurs shortly before or after application.

#### 4.2.6 Residual Herbicides

By definition, a residual herbicide is applied to weeds and soil where rainfall is needed to wash the herbicide off the plant foliage into the soil (Table 4.1). Once activated by precipitation, it is then absorbed by the roots or shoots of susceptible plants and translocated upward throughout other growing points. Injury symptoms will not be seen until the susceptible weed has actively translocated the herbicide. It may take the herbicide several weeks to reach the roots of some deep-rooted targeted plants. Often referred to as soil-applied herbicides, the residual activity may range from several months to none. Residual treatments will usually benefit from a timely moderate rainfall event. However, precautions should be taken during application to prevent their movement into non-target areas. Do not apply residual herbicides to sensitive areas, which include frozen ground, or areas where they may move into water sources, cropping areas or leach into groundwater (sensitive areas).

**Table 4.1.** Classification of Herbicide Uptake and Activity.

Group 1 (Primarily Foliar Uptake)	Class <sup>1</sup>	Group 2 (Primarily Soil Residual Activity)	Class <sup>1</sup>
Roundup Pro Concentrate* (glyphosate)	T, N or S	Oust XP (sulfometuron)	S
MSMA* (MSMA)	C, S	Plateau	S
Campaign	T, S	Diuron 80 WDG	S
Vanquish	T, S	Tordon	S
Banvel (dicamba)	T, S	Arsenal (imazapyr)	N or S
Garlon 4 Ultra or 3A (triclopyr ester)	T, S	Escort XP (metsulfuron methyl)	S
Krenite	C, S	Outrider	S
Overdrive	T,S	Milestone VM	S
Transline	T, S		

<sup>1</sup>C=contact; T=translocated, N=nonselective, S=selective.

**Table 4.2.** Herbicide Mode of Action and Herbicide Resistance in Plants.

Herbicides(s)	Mode of Action	Known Resistance
Oust XP (sulfometuron)	Inhibits Alanine Synthesis Enzyme Formation	Yes
Outrider		Yes
Escort XP (metsulfuron methyl)		Yes
Plateau		Yes
Arsenal (imazapyr)		Yes
Diuron 80 WDG	Inhibits Photosynthesis	Yes
Banvel (dicamba)	Disrupts Cell Division and Growth	No
Vanquish		No
Overdrive		No
Garlon 4 Ultra or 3A		No
Milestone VM		No
Transline		No
Tordon		No
Krenite	Inhibits Cell Division	No
MSMA (MSMA)	Causes Cell Membrane Disruption	No
Roundup Pro Concentrate (glyphosate)	Inhibits Amino Acid Formation and Protein Synthesis	Yes

### 4.3 FACTORS AFFECTING HERBICIDE ACTIVITY

There are several factors which influence the effectiveness of chemical weed control program. Using the right herbicide and applying it correctly are the most important factors which determine the final outcome. However, there are some environmental factors which can have a negative or positive effect on chemical weed control. Environmental factors which affect chemical weed control can be divided into three (3) groups: climatic, plant and soil factors.

### **4.3.1 Climatic Factors**

Temperature affects the amount of time required for an herbicide to do its job. When air temperatures are between 18°C and 29°C (65°F and 85°F), a plant is rapidly growing and herbicides will be more effective. High air temperatures, however, can lead to increased herbicide losses through increased degradation (herbicide breakdown) and volatilization. During long periods of cold weather, the activity of the herbicide may be slowed down.

High relative humidity allows a foliar-applied herbicide to enter the plant more readily than at lower relative humidity. Low humidity may decrease plant uptake of herbicides and dry out soils so that less movement to plant roots occurs and volatility of herbicides increases. The optimum times to spray foliar-applied herbicides are during periods of high humidity and moderate air temperature.

Precipitation occurring soon after an herbicide application may be beneficial or detrimental depending upon the type of herbicide applied. A moderate (1 inch [2.54 cm] or less) rainfall event soon after a soil-applied preemergence herbicide (Diuron 80 WDG) application will move the herbicide down into the soil where it is needed for activation. A rainfall event occurring shortly after an application of a foliar-applied herbicide such as Vanquish will drastically reduce the level of weed control. A foliar-applied herbicide should not be applied if rainfall is expected within a few hours. The applicator may have to make the decision not to spray due to the chance of rainfall occurring.

Wind is definitely the most important climatic factor affecting chemical weed control. Excessive wind does not have a direct effect on herbicide uptake, metabolism

or herbicide performance; however, its indirect influence is a major problem. Excessive wind (greater than 10 mph [16 kph]) tends to distort or bend spray patterns and hinders proper application of the herbicide due to the drift of herbicide spray droplets. In 1994, ODOT initiated an herbicide policy (refer to Section 4.6) which in Section III of the policy states “When applying herbicide, the average wind speed shall be less than 10 mph (16 kph). A drift retardant or drift control agent shall be used with any chemical being applied, and the maximum pressure (at the nozzle) shall not exceed 25 pounds per square inch (172.375 kpa).” The implementation of this policy will improve the application; however, knowing when not to spray because of excessive wind is more important. Applying herbicides in the early morning or late evening hours or sometimes possibly at night may help avoid the more windy parts during the day.

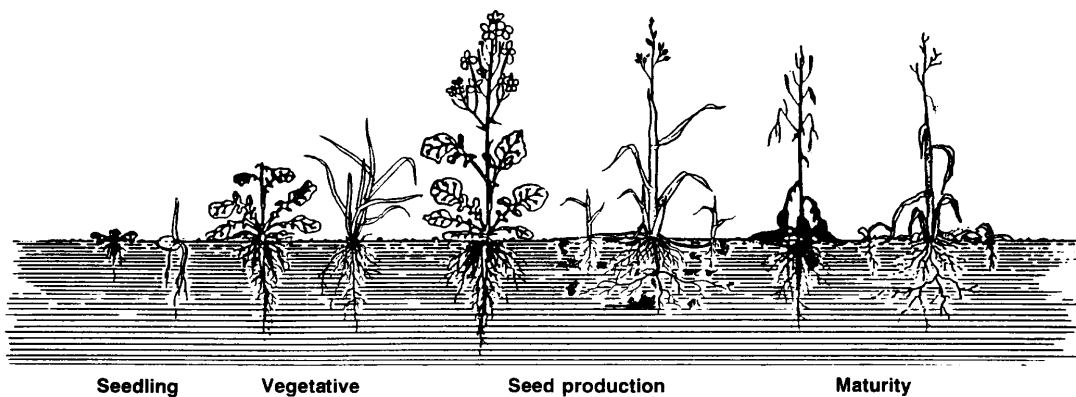
#### **4.3.2 Plant Factors**

Some herbicides enter a plant primarily through the leaf surface and stems (foliar-applied and foliar uptake). The cuticle and wax on leaf surfaces are barriers that herbicides must penetrate before they can enter the leaf. Older or more mature plants or plants under stress will tend to have thicker, waxy layers making herbicide penetration into the leaves more difficult and the weeds harder to control. It may be necessary to use a crop oil when making a late season herbicide application to more mature weeds. Also, on the leaf surface of certain plants, there may be an abundance of leaf hairs. Herbicide spray droplets have a tendency to stand up on the leaf hairs without contacting the leaf surface. The addition of a surfactant to the spray mixture

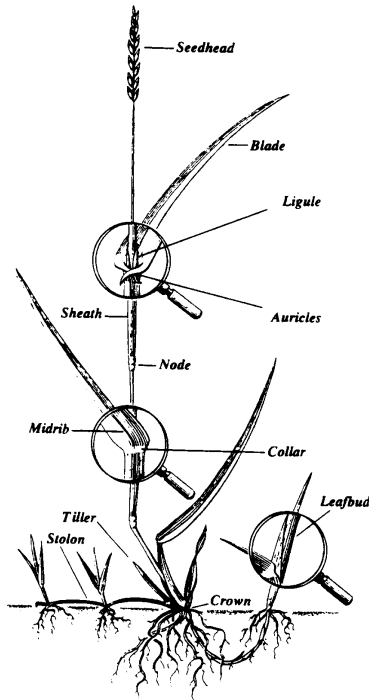
would allow the spray droplet to penetrate through the leaf hairs allowing the herbicide to contact the leaf surface.

Another important plant factor which influences herbicides is the growth pattern or growth stage of the targeted weed. Each year weeds normally complete four stages of growth: (1) seedling, (2) vegetative, (3) seed production and (4) maturity (Figure 4.1). Annual and biennial weeds are easier to control at the seedling stage, but perennial weeds can be more effectively controlled during their vegetative stage. Treating perennial weeds at this growth stage allows for better control of the underground parts of the plant.

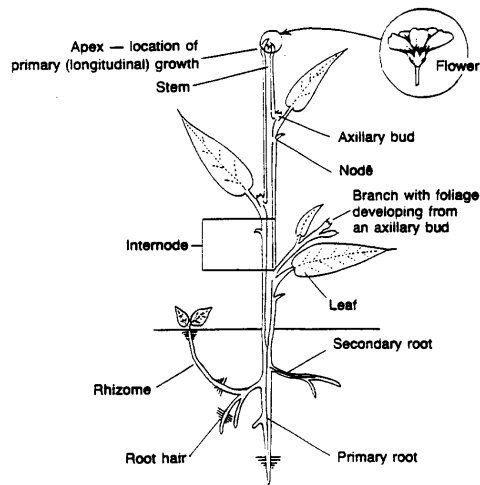
Location of growing points on a plant can affect their level of control. Applying an herbicide directly to the growing point will generally increase the effectiveness of the herbicide. A seedling grassy weed has had its growing point(s) protected below the soil surface which makes it difficult to apply an herbicide directly to these areas (Figure 4.2). A seedling broadleaf weed has an exposed growing point (apex) at the top of the plant and along leaf axils (Figure 4.3). Herbicide can be applied directly to the growing points on broadleaf plants.



**Figure 4.1.** Four growth stages of a weed.



**Figure 4.2.** Parts of a grass plant.



**Figure 4.3.** Parts of a broadleaf plant.

### 4.3.3 Soil Factors

The texture and organic matter content of a soil have a definite effect on soil-applied herbicides such as Diuron 80 WDG and sulfometuron. Soil texture is determined by the percent, by weight, of sand, silt and clay in the soil. Soils with high clay content will tie up or adsorb herbicide particles making them unavailable for effective weed control. Higher herbicide rates may be recommended on fine-textured clay soils. Sandy or silty soils do not adsorb very much of the herbicide, which allows more herbicide to be available for weed control. Lower rates of soil-applied herbicides can be used on coarse-textured sandy soils without sacrificing weed control (refer to specific herbicide label for range of rates). The roadside rights-of-way in Oklahoma



have a wide variety of soil textures which range from very fine-textured clay soils to very coarse-textured sandy soils. Erratic weed control from the proper application of a soil-applied root uptake herbicide can sometimes be attributed to soil texture.

Soil organic matter content also has a dramatic effect on soil-applied root uptake herbicides, especially on organic herbicides. Soils with two percent organic matter content or greater will require higher herbicide rates for successful weed control (refer to specific herbicide label for range of rates). Soils with higher organic matter content have a greater potential ability to tie up or adsorb herbicides than any other soil factor. Most of the roadside rights-of-way soils found in Oklahoma will usually have less than three percent organic matter.

The soil pH is another factor which affects soil-applied herbicides. Some herbicides, such as Sulfometuron XP, may be more effective in soils with a high pH (higher than 7.0). Other herbicides, such as Diuron 80 WDG, are relatively unaffected by soil pH.

#### **4.3.4 Water Quality Characteristics**

Several herbicides can be affected by the pH of the water used for mixing (carrier).

**pH.** The pH of a water source is dependent on the amount of hydrogen ions that are present. The pH from a given treated water source will fluctuate over time and is dependant on the water source itself and the treatment the water receives. A normal pH range for treated water would be between 6.5 and 8.5 (5). A water pH of 7.0 is

considered neutral. A pH value below 7.0 is acid, and above 7.0 is alkaline. Water pH has a definite affect on herbicides. Herbicide solubility, persistence, and compatibility are all issues that can be affected. Herbicides such as glyphosate, Campaign, or Vanquish will benefit from being mixed with slightly acidic water in a pH range of 6.5-6.9 (1). However, herbicides such as sulfometuron and Outrider (sulfosulfuron), both sulfonyl urea family members, will be susceptible to breakdown from an increase in water hydrolysis in acidic water (2). Of all the possible effects that could occur from water pH, the most significant to ODOT is the affect of mixing sulfonyl urea herbicides in acidic water. Mixing herbicides such as sulfometuron, Outrider, or metsulfuron methyl in water with a pH below 6.5 will significantly reduce the effectiveness if left in the water overnight. If using acidic water with these herbicides the key is to only mix the amount of herbicide that can be used in a four hour period. If there is potential for a tank load of these herbicides to be held overnight it would be necessary to buffer the water before the herbicide mixture is made.

Since water pH changes during the year it will may be necessary for some ODOT facilities to measure pH levels at their facility. There are accurate, inexpensive, and easy-to-use pH monitoring kits that can be purchased. However, we are not recommending that any ODOT facilities purchase these kits at this time. If it is necessary to modify the water pH, there are several adjuvants (specifically pH modifying adjuvants and buffering agents) available from distributors that can be used and are listed in Table 1.

**Hardness.** Water is considered to be hard or soft based on the amount of magnesium and calcium that is present. Other minerals such as sodium and iron also

play a part in water hardness. Hard water will have a high level of these minerals present and when in the presence of a high pH can have a negative effect on herbicides. Herbicides such as glyphosate, when used at selective ODOT rates, can show reduced effectiveness with water test hardness values of 350 or greater (4). The best way to prevent the negative effects from hard water is to mix only the amount of herbicide you can use within 4 hours. If this is not possible the negative effects from hard water can be overcome with the use of ammonium sulfate to lower the water pH. The effects from hard water should not be a big problem for ODOT facilities unless a water source has hardness values of 350 or higher along with pH levels of 8.0 or higher. Under these conditions the use of ammonium sulfate will likely be necessary to obtain the complete effectiveness from the use of either glyphosate, Campaign, or glyphosate tank mixes.

**Electrical Conductivity (EC).** The sum of all the minerals dissolved in a sample of water is normally referred to as the total dissolved solids (TDS). The higher the TDS, the more electric current water can conduct. Because of this characteristic, a measure of the electrical conductivity (EC) is often used to provide a quick, economical estimate of the total dissolved solids in water. If the EC is less than 500 micro Siemens/cm [ $\mu\text{s}/\text{m}$ ], water quality problems for herbicides are very unlikely (3, 4). Similar to water hardness, high EC values ( $>500 \mu\text{s}/\text{m}$ ) are more of a concern when present with high water pH.

**Table 4.3.** Water quality characteristics for 2005 Division One water samples.

ODOT Field Division	Division Facility	Collection Date	LabID	pH	EC (µs/m)	Hardness (ppm)
1	Checotah Interstate	March/April	<u>375183</u>	7.6	282	80
		June/July	384544	8	494	156
1	Sallisaw Interstate	March/April	<u>375184</u>	7	81.61	24
		June/July	384545	7.6	87	28
1	Muskogee County	March/April	<u>375185</u>	7.4	263	116
		June/July	384546	7.7	327	148
1	Cherokee County	March/April	<u>375186</u>	7.9	262	118
		June/July	384547	8.1	293	129
1	Adair County	March/April	<u>375187</u>	7.7	202	101
		June/July	384548	8.1	221	116
1	Sequoyah County	March/April	<u>375188</u>	7.1	82.92	24
		June/July	384550	7.2	84	32
1	Haskell County	March/April	<u>375189</u>	7	108.4	23
		June/July	384551	7.2	127	25
1	McIntosh County	March/April	<u>375190</u>	7.6	278	81
		June/July	384552	7.8	315	93
1	Okmulgee County	March/April	<u>375191</u>	7.2	167.4	58
		June/July	384553	7.6	184	68
1	Wagoner County	March/April	<u>375192</u>	7.7	260	121
		June/July	384554	7.7	296	137

**Table 4.4.** Water quality characteristics for 2005 Division Two water samples.

ODOT Field Division	Division Facility	Collection Date	LabID	pH	EC (µs/m)	Hardness (ppm)
2	Atoka County	March/April	<u>370304</u>	7.8	165.9	31
		June/July	384462	7.8	180	41
2	Bryan County	March/April	<u>370305</u>	8.1	272	117
		June/July	384463	8.3	472	260
2	Choctaw County	March/April	<u>370306</u>	7.9	106.5	18
		June/July	384464	7.8	126	32
2	Latimer County	March/April	<u>370307</u>	7.4	81.86	27
		June/July	384465	7.7	103	37
2	Leflore County	March/April	<u>370308</u>	6.8	145.1	54
		June/July	384466	7.2	150	53
2	McCurtain County	March/April	<u>370309</u>	6.9	137.3	53
		June/July	384467	7.4	148	56
2	Marshall County	March/April	<u>370310</u>	8.1	281	132
		June/July	384468	8.1	287	138
2	Pittsburg County	March/April	<u>370311</u>	8.3	327	36
		June/July	384470	7.7	159	37
2	Pushmataha County	March/April	<u>370312</u>	8	147.3	18
		June/July	384471	8	163	25
2	Talihina Yard	March/April	<u>375182</u>	7.8	113.2	19
		June/July	384472	7.8	122	17

**Table 4.5.** Water quality characteristics for 2005 Division Three water samples.

ODOT Field Division	Division Facility	Collection Date	LabID	pH	EC (µs/m)	Hardness (ppm)
3	Purcell Interstate	March/April	NA	NA	NA	NA
		June/July	385971	8.3	804	237
3	Shawnee Interstate	March/April	<u>375181</u>	8.3	610	252
		June/July	385972	8.1	549	230
3	Seminole County	March/April	<u>370335</u>	7.9	158	47
		June/July	385973	7.8	177	51
3	Pontotoc County	March/April	<u>370336</u>	8.3	604	237
		June/July	385974	8.2	600	370
3	Garvin County	March/April	<u>370337</u>	8	270	87
		June/July	385975	8	341	133
3	McClain County	March/April	<u>370338</u>	8.5	735	211
		June/July	385976	8.3	651	225
3	Coal County	March/April	<u>370340</u>	7.3	100.2	26
		June/July	385977	7.6	133	42
3	Hughes County	March/April	<u>370341</u>	7.5	191.6	64
		June/July	385978	7.6	219	75
3	Okfuskee County	March/April	<u>370342</u>	7.6	256	78
		June/July	385980	7.7	269	86
3	Johnston County	March/April	<u>370343</u>	8.6	504	294
		June/July	385981	8.4	403	230
3	Lincoln County	March/April	<u>370344</u>	8.2	355	146
		June/July	385982	7.9	399	157
3	Pottawatomie County	March/April	<u>370346</u>	8.4	583	231
		June/July	385983	8.1	672	243

**Table 4.6.** Water quality characteristics for 2005 Division Four water samples.

ODOT Field Division	Division Facility	Collection Date	LabID	pH	EC (µs/m)	Hardness (ppm)
4	Guthrie Interstate	March/April	<u>370314</u>	8.5	1243	17
		June/July	383961	8.4	1152	14
4	Tonkawa Interstate	March/April	<u>370315</u>	8	495	121
		June/July	383962	7.7	453	94
4	Noble County	March/April	<u>370316</u>	8.1	345	109
		June/July	383963	8.1	364	112
4	Garfield County	March/April	<u>370317</u>	8.4	754	288
		June/July	383964	8.3	686	276
4	Payne County	March/April	<u>370318</u>	8.3	938	134
		June/July	383965	8.3	514	214
4	Logan County	March/April	<u>370320</u>	8.6	1466	21
		June/July	383966	8.5	1180	15
4	Kay County	March/April	<u>370321</u>	8.3	503	132
		June/July	383967	7.6	452	95
4	Kingfisher County	March/April	<u>370322</u>	8.5	738	281
		June/July	383968	7.8	706	282
4	Grant County	March/April	<u>370323</u>	8.4	795	330
		June/July	383969	8.4	738	308

**Table 4.7.** Water quality characteristics for 2005 Division Five water samples.

ODOT Field Division	Division Facility	Collection Date	LabID	pH	EC (µs/m)	Hardness (ppm)
5	Hydro Interstate (Geary)	June/July	383970	8.3	549	257
5	Elk City Interstate	March/April	<u>375145</u>	8.3	681	337
		June/July	383971	8.4	660	331
5	Hydro Interstate	March/April	<u>375146</u>	8.3	756	290
		June/July	383972	8.2	726	265
5	Beckham County	March/April	<u>375147</u>	8.5	623	310
		June/July	383973	8.1	606	298
5	Custer County	March/April	<u>375148</u>	8.4	683	265
		June/July	383974	8.4	626	242
5	Jackson County	March/April	<u>375150</u>	8	785	224
		June/July	383975	8.1	744	204
5	Tillman County	March/April	<u>375151</u>	8	788	229
		June/July	383976	8.1	773	200
5	Kiowa County	March/April	<u>375152</u>	8.2	832	293
		June/July	383977	8.3	816	281
5	Greer County	March/April	<u>375153</u>	8.3	418	168
		June/July	383978	8.1	411	147
5	Washita County	March/April	<u>375154</u>	8.5	624	298
		June/July	383980	8.2	772	277
5	Roger Mills County	March/April	<u>375155</u>	8.6	670	236
		June/July	383981	8.4	636	192
5	Blaine County	March/April	<u>375156</u>	8.5	688	335
		June/July	383982	8.3	600	274
5	Dewey County	March/April	<u>375157</u>	7.8	266	97
		June/July	383983	8.1	263	74
5	Harmon County	March/April	<u>375158</u>	8.6	609	273
		June/July	383984	8.3	598	251



**Table 4.8.** Water quality characteristics for 2005 Division Six water samples.

ODOT Field Division	Division Facility	Collection Date	LabID	pH	EC (µs/m)	Hardness (ppm)
6	Texas County	March/April	<u>370325</u>	8.3	641	274
		June/July	383985	8.4	533	258
6	Woodward County	March/April	<u>370326</u>	8.1	424	202
		June/July	383986	8.2	390	184
6	Woods County	March/April	<u>370327</u>	3.2	444	194
		June/July	383987	7.7	461	199
6	Alfalfa County	March/April	<u>370328</u>	8.4	1593	658
		June/July	383988	8.5	1490	647
6	Major County	March/April	<u>370329</u>	8.3	612	263
		June/July	383989	7.8	600	259
6	Beaver County	March/April	<u>370330</u>	8.5	607	243
		June/July	383990	8.2	636	250
6	Cimarron County	March/April	<u>370331</u>	8.3	585	252
		June/July	383991	8.3	553	236
6	Ellis County	March/April	<u>370332</u>	8.2	495	232
		June/July	383992	8.3	451	211
6	Harper County	March/April	<u>370333</u>	8.3	663	243
		June/July	383993	8.3	624	220

**Table 4.9.** Water quality characteristics for 2005 Division Seven water samples.

ODOT Field Division	Division Facility	Collection Date	LabID	pH	EC (µs/m)	Hardness (ppm)
7	Caddo County	March/April	<u>375160</u>	8.2	511	225
		June/July	384217	8.0	538	239
7	Carter County	March/April	<u>375168</u>	8.3	404	184
		June/July	384218	8.1	438	192
7	Comanche County	March/April	<u>375161</u>	8.3	458	187
		June/July	384220	8.1	471	200
7	Cotton County	March/April	<u>375162</u>	8.0	366	131
		June/July	384221	8.2	421	133
7	Grady County	March/April	<u>375163</u>	8.1	518	227
		June/July	384222	7.9	528	250
7	Jefferson County	March/April	<u>375164</u>	8.2	536	209
		June/July	384223	8.1	578	225
7	Love County	March/April	<u>375165</u>	8.8	865	17
		June/July	384224	8.6	964	25
7	Murray County	March/April	<u>375166</u>	8.3	399	180
		June/July	384225	8.2	438	203
7	Stephens County	March/April	<u>375167</u>	8.3	546	208
		June/July	384226	8.3	608	237
7	Ardmore Interstate	March/April	<u>375168</u>	8.3	404	184
		June/July	384218	8.1	438	192

**Table 4.10.** Water quality characteristics for 2005 Division Eight water samples.

ODOT Field Division	Division Facility	Collection Date	LabID	pH	EC (µs/m)	Hardness (ppm)
8	Craig County	March/April	<u>375170</u>	7.7	281	134
		June/July	383994	8.1	305	131
8	Nowata County	March/April	<u>375171</u>	8.2	479	236
		June/July	383995	7.9	200	78
8	Osage County	March/April	<u>375172</u>	8.4	483	225
		June/July	383996	8.2	325	135
8	Ottawa County	March/April	<u>375173</u>	8.2	760	160
		June/July	383997	8.3	392	119
8	Washington County	March/April	<u>375174</u>	7.9	285	128
		June/July	383998	7.9	203	76
8	Rogers County	March/April	<u>375175</u>	7.8	220	77
		June/July	384000	7.4	257	82
8	Delaware County	March/April	<u>375176</u>	8.1	249	121
		June/July	384001	7.8	200	73
8	Pawnee County	March/April	<u>375177</u>	8.0	230	103
		June/July	384002	8.0	57	97
8	Mayes County	March/April	<u>375178</u>	8.1	471	194
		June/July	384003	7.7	400	138
8	Creek County	March/April	<u>375180</u>	8.5	484	243
		June/July	384004	8.5	488	229

**Table 4.11.** Partial listing of commercially available adjuvants and their potential effects on water quality and spray characteristics.

<b>Adjuvant Name</b>	<b>Manufacturer</b>	<b>Effect on pH</b>	<b>Other effects:</b>
LI-700	Loveland Products	Lowers pH	Also a surfactant
Buffer P.S.	Helena Chem. Co.	Lowers pH	
Buffer Extra Strength	Helena Chem. Co.	Lowers pH	Reduces hard water effects
Induce	Helena Chem. Co.	Lowers pH	Also a surfactant
Quest	Helena Chem. Co.	Lowers pH	Also adjusts alkalinity
Request	Helena Chem. Co.	Lowers pH	Reduces hard water effects
Accuquest	Helena Chem. Co.	Lowers pH	Reduces hard water effects, deposition aid
Interactive	Helena Chem. Co.	Lowers pH	Also a surfactant, reduces foam
AquabupH	Brewer Inter.	Lowers pH	Also a surfactant
Surfactant PH	Brewer Inter.	Lowers pH	Also a surfactant
Correct PH	Estes, Inc.	Lowers pH	Also a surfactant
Duke	Estes, Inc.	Lowers pH	
Surf King Plus	Estes, Inc.	Lowers pH	Also a surfactant
Aqua-King Plus	Estes, Inc.	Lowers pH	Also a surfactant
Ballast	Agriliance LLC	Lowers pH	
PAS-800	Drexel Chem. Co.	Lowers pH	Also a surfactant
Spray Prep Liquid	Kalo, Inc.	Lowers pH	Reduces hard water effects
Red River Ultra 92	Red River Spec.	Lowers pH	Also a surfactant
Red River 90	Red River Spec.	Lowers pH	Also a surfactant

There are a large number of products on the market that are ammonium sulfate (AMS) based and can be effectively used to lower pH. These can be purchased in a liquid or dry form. Some of these products are blends of AMS with other chemicals that modify the spray solution in ways that may or may not be of use to ODOT. Consult OSU personnel for recommendation on specific AMS based adjuvants. Some of the materials listed may not be listed on the current Approved Herbicide and Adjuvant List.

## **4.4 HERBICIDE FATE**

There are several factors which influence the fate of an herbicide after application. These may include leaching, adsorption, photodegradation, volatilization, microbial degradation, absorption and hydrolysis.

### **4.4.1 Leaching**

Leaching of an herbicide occurs as a result of water movement downward through the soil rather than over the soil surface. Leaching depends on factors including herbicide solubility, adsorption (refer to Section 4.4.2) and soil texture (refer to Section 4.3.3). An herbicide that is soluble (dissolves) in water can move with water through the soil. As herbicide solubility increases, the more potential there is for leaching to occur. An herbicide that is held strongly to soil particles by adsorption is less likely to leach. Also, a sandy soil has a greater chance of herbicide leaching due to its higher water infiltration and percolation rate. A certain amount of herbicide leaching may be essential for weed control. However, too much leaching may result in reduced weed control, injury to non-target plants and groundwater contamination.

### **4.4.2 Adsorption**

Adsorption may be defined as the process by which an herbicide is held or retained on the surface of soil particles. There are several soil factors which influence herbicide adsorption. It is one of the major processes controlling the fate of soil-applied herbicides. Soils which are high in either clay or organic matter content are more adsorptive than coarse or sandy soils. This is due in part to organic or clay particles

having more surface area or more sites onto which herbicides can bind. Soil moisture also affects herbicide adsorption. Wetter soils will tend to adsorb less herbicide than dryer soils because water molecules will compete with a soil-applied herbicide for binding sites on the soil particles. This problem results in reduced weed control. For example, targeted weeds may not be adequately controlled if a soil-applied herbicide is tightly held to soil particles (adsorbed). This is due to a decrease in the availability of the herbicide for root uptake by the targeted plant. Adsorption also reduces the potential for leaching, thereby decreasing potential groundwater contamination.

#### **4.4.3 Photodegradation**

Photodegradation, commonly referred to as photodecomposition or photolysis, is the process by which sunlight breaks down or decomposes an herbicide. Light can break down herbicides on the soil surface and on plant foliage. Some of the factors that influence herbicide photodegradation include sunlight intensity, properties of the application site, the application method and herbicide properties. Soil-applied herbicide losses from photo degradation may be reduced by rainfall or irrigation during or immediately after application. This water washes residues from the canopy into the soil surface.

#### **4.4.4 Volatilization**

Volatilization refers to the process by which an herbicide is converted from either a solid or liquid state into a gas or vapor form. Once volatilized (changed into a gas), an herbicide can move in air currents away from the treated area. An important factor in

determining whether an herbicide will volatilize is vapor pressure. The higher the vapor pressure of an herbicide, the more volatile it becomes. Volatilization of an herbicide can result in vapor drift, which is the movement of herbicide vapors or gases into the atmosphere or air. Herbicides such as Vanquish, Overdrive, and Garlon 4 Ultra are examples which are more prone to volatilization. Herbicide volatilization loss or drift can result in reduced weed control and lead to injury of non-target species of plants. Several environmental factors such as high temperatures, low relative humidity and air movement (wind) tend to increase herbicide volatilization. Also, herbicides which are tightly adsorbed by soil particles are less likely to volatilize. To reduce or minimize volatilization, avoid applying potentially volatile herbicides on dry soils and on very hot, dry days.

#### **4.4.5 Microbial Degradation**

Microbial degradation is the process by which herbicides are broken down by fungi, bacteria and other microorganisms that use herbicides as a food source. The majority of microbial degradation of herbicides occurs in the soil. Environmental factors which affect the rate of microbial degradation include temperature and moisture. Cool temperatures and dry soils will tend to extend the life of soil-applied herbicides due to the reduction of microbial activity. Soil adsorption of herbicides also reduces the rate of microbial degradation.

#### **4.4.6 Absorption**

Absorption or uptake is the process by which an herbicide enters into plants. In order for an herbicide to be effective or provide adequate weed control, it must be absorbed by the targeted weed. Absorption of herbicides is influenced by environmental conditions, by the chemical and physical properties of the herbicide and by the soil. Although herbicides differ in their mode of action and plant surfaces differ in their ability to absorb herbicides, the chemical properties of an herbicide also determine the degree to which they can be taken up by the plant. Herbicides are commonly absorbed through roots or leaves, although stems and seeds may also absorb the herbicide. High temperatures will tend to increase absorption. Also, a corresponding decrease in humidity will tend to decrease absorption.

#### **4.4.7 Hydrolysis**

Hydrolysis is a breakdown process in which the herbicide reacts with water. It is one of the most common herbicide degradation reactions. Soil-applied herbicides such as sulfometuron are broken down through hydrolysis. Many of the organophosphate and carbonate insecticides are particularly susceptible to hydrolysis under alkaline conditions (pH greater than 7.0). Some chemicals may be actually broken down within a matter of hours when mixed with alkaline or acidic water (carrier).

### **4.5 DRIFT AND OFF-TARGET MOVEMENT**

Minimizing off-target herbicide movement or exposure is a major concern during a right-of-way application. Most of the herbicides commonly applied along roadsides in



Oklahoma have the potential to cause serious injury to adjacent agronomic crops and other susceptible non-targeted plants. There are several factors which can influence the off-target movement of herbicides from rights-of-way. Some of these include drift, spray characteristics, application equipment and techniques, weather conditions and movement of soil-applied herbicides.

#### **4.5.1 Drift**

Drift is defined as the air movement of the herbicide away from the targeted site to an area not intended for treatment. There are two types of spray drift which can occur while applying herbicides along roadsides. The first and most common is physical or particle drift. This is the movement by air of the actual herbicide spray particle to an off-target area. Physical drift occurs while the actual spray application is taking place. The second type of drift which can occur, although less commonly observed, is vapor drift or volatilization as previously referred to in Section 4.4.4. Vapor drift usually occurs after a roadside herbicide application is made as the air temperature increases. The vapors from volatile herbicides, such as 2,4-D, or Vanquish can be carried downwind by air currents to off-target areas. Susceptible, non-targeted plants in the path of the vapor drift may possibly be affected or injured. In an effort to minimize the amount of potential physical herbicide drift, the Oklahoma Department of Transportation implemented a “Herbicide Program Policy” in 1994 to address this concern (refer to Chapter 4.6 in this manual, under Part III of the ODOT Herbicide Program Policy).

#### **4.5.2 Spray Characteristics**

There are several spray characteristics which can influence the off-target movement of herbicides from rights-of-way including drift. These include herbicide formulation, size, density and evaporation rate of the herbicide spray droplets. Dust formulations of herbicides are subject to more physical or particle drift than sprays (liquids). Granular or pelletized herbicide formulations will produce the least amount of drift during application. Some herbicide formulations which are commonly used for roadside weed control are volatile and therefore are prone to vapor drift as well as to particle drift. As a result, certain herbicides pose a greater drift hazard than others because small amounts of the active ingredient can result in severe damage to off-target, susceptible plants. The selection of the herbicide formulation is very important in areas where drift control is critical. The high-volatility (HV) ester formulations of the phenoxy herbicides will volatilize at air temperatures of approximately 10°C (50°F). Very few of these formulations are available to purchase today because they are so prone to vapor drift. The more common ester formulations available are the low-volatility (LV) which can volatilize at an air temperature of approximately 29°C (85°F). The amine (salt) formulations of herbicides, such as Vanquish, do not volatilize as readily and should be used in place of the ester formulations whenever possible, especially in environmentally sensitive areas. Ester herbicide formulations are often recommended for use on hard-to-control species or in basal-bark applications. Basal-bark applications made during the dormant season will minimize vapor drift injury to nearby sensitive off-target plants.

Small herbicide spray droplets fall more slowly to the target site than do larger droplets. Because smaller droplets are airborne longer, they are more likely to be carried out of the targeted area.

Lightweight (or less dense) spray particles will drift further than heavier (more dense) ones. Oil droplets are lighter than water droplets and will tend to stay airborne longer and drift further. Oils are sometimes added to spray mixtures of volatile herbicides for the treatment of woody species. This type of treatment can be hazardous if used in an unsafe manner. Additionally, it is recommended that herbicides mixed with oil carriers only be applied using low pressure backpack sprayers.

Evaporation decreases the size of spray droplets and temperature affects the evaporation rate. On hot days, the evaporation rate is greater, resulting in smaller droplets and more potential for drift. Water droplets will evaporate more rapidly than oil droplets.

#### **4.5.3 Application Equipment and Techniques**

Nozzle types and operating conditions will influence the size of spray droplets produced. Conventional nozzles, such as the off-center type, produce a wide range of spray droplet sizes including small droplets that are more likely to drift. The number of small droplets produced will depend primarily upon the nozzle design and operating pressure. More small spray droplets are produced as the nozzle pressure increases. Although high pressure is sometimes used because it produces fine droplets that blanket the foliage (not recommended for roadside use in Oklahoma), this type of application has a high drift potential. Instead, it is safer to apply the herbicide by using

the lowest pressure which will produce a uniform spray pattern. Currently, a pressure of 25 psi (172 kPa) is recommended for broadcast herbicide applications by ODOT applicators along roadsides in Oklahoma (refer to Section 4.6 in this manual, Part III of the ODOT Herbicide Program Policy). Certain low-pressure nozzles, drift reduction nozzles and BoomBuster spray nozzles have been designed to reduce the number of small droplets in the spray pattern. Nozzles with large orifices (openings) will produce a greater flow rate and more larger diameter droplets than nozzles with small orifices. Although flow rate can be increased by raising the operating pressure of the nozzle, this method will increase drift. If there is a need to increase or apply a higher carrier rate, then it would be best to change to a nozzle tip with a larger orifice.

The angle of the spray pattern also affects the size of spray droplets. A finer spray (smaller droplets) is produced as the fan angle from a particular nozzle increases. For example, a 110-degree angle spray pattern produces more small droplets than an 80-degree spray pattern even though both tips have identical flow rates. Spray boom height is another important factor influencing spray particle drift. The use of wider angle nozzle tips will permit a lower boom height which reduces the distance to the target and thus reduces drift.

Another technique for controlling drift is the addition of spray thickeners or drift control additives (refer to Section 4.6 in this manual, Part III of the ODOT Herbicide Program Policy or Sections 6.1 or 6.2 in this manual). Drift control additives are designed to increase the viscosity of the herbicide spray mixture. As a result, the spray droplets exiting from the nozzle tip become larger and heavier.

Invert emulsion systems have been used in some areas to reduce drift. The current use of these systems in Oklahoma is limited because they require special application techniques and equipment. Using a special mixing method, the herbicide spray mixture is suspended in an oil carrier. The resulting viscous emulsion usually has the consistency of mayonnaise and has been noted to significantly reduce drift problems while at the same time aid in spray deposition.

#### **4.5.4 Weather Conditions**

The major weather factor affecting roadside spray applications and drift is wind speed and direction. High wind conditions usually limit or reduce the number of days when herbicides can be safely applied along roadsides. ODOT's Herbicide Program Policy states that spraying should be avoided when wind velocity exceeds 10 mph (16.1 kph). However, even winds of lesser velocity can carry fine spray particles into non-target areas under certain situations.

Generally speaking, air is least turbulent just before sunrise and just after sunset. Air (or wind) is usually most gusty and turbulent during mid-afternoon. The amount of air turbulence is determined by the difference between the temperature at ground level and the temperature of the air above it. The warmer air then rises and is replaced by the cooler air, thus creating air currents. The temperature differential is usually least during early morning or late evening. As the temperature difference increases after sunrise, the mixing may become more turbulent carrying spray particles out of the target area. Applicators should always be aware of wind direction. Wind direction will determine where fine spray particles will move during and immediately after spraying.

One of the important responsibilities of an applicator is to keep in mind wind speed and direction around sensitive areas.

When the air near the soil surface is cooler than the air above it, the warm air overhead remains on top and no vertical mixing occurs. This condition is known as an inversion. Low-wind conditions with high inversion (ground air 2°F to 5°F [1°C to 3°C] cooler than the air above it) may cause spray droplets to remain suspended in the layer of cold, undisturbed air and eventually cause them to move out of the targeted area with a breeze. Herbicides should not be applied along roadsides when inversion conditions exist.

Temperature and humidity also affect drift of the spray particles. High temperatures and low humidity increase the evaporation rate of spray droplets. Small spray droplets which completely evaporate, can leave herbicide crystals suspended in the air which can then be carried to off-target susceptible plants.

#### **4.5.5 Movement of Soil-Applied Herbicides**


The movement of soil particles by moving water or wind is soil erosion. Most erosion occurs with moving water during rainstorms in areas with little or no vegetative ground cover. Soil-applied herbicides attached to eroding soil particles can be deposited in non-target areas. Soil erosion may be reduced by promoting a good vegetative ground cover on sloped areas (backslopes and/or fill slopes), ditches or waterways. Herbicides which are very soluble in water (Hyvar, sulfometuron, Spike) can also move into non-target areas with runoff or by lateral movement of surface water runoff. The use of highly water-soluble herbicides should be avoided in areas near

waterways or uphill from sensitive areas since they may be moved out of the target area before being adsorbed by the soil particles. This results in poor weed control and potential injury to non-target plants. On sloped areas, the herbicide should be applied as a spray (liquid formulation) to reduce the chance of runoff.

#### **4.6 ODOT HERBICIDE PROGRAM POLICY**

In 1994, the Oklahoma Department of Transportation developed and adopted an “Herbicide Program Policy” (Policy Directive No. D-504-1). The primary goals of this policy were to improve and promote the credibility and quality of ODOT’s ongoing roadside vegetation management herbicide program. The goals of the “Herbicide Program Policy” would be achieved by focusing on implementation of ODOT applicator certification, training and herbicide application specifics as outlined in the following document.

The ODOT Herbicide Program Policy Directive follows:

OKLAHOMA DEPARTMENT OF TRANSPORTATION			
POLICY DIRECTIVE		NO. D-504-1	
SUBJECT HERBICIDE PROGRAM		PAGE NO. 1 OF 2	DATED 8-01-95
EFFECTIVE DATE 8-01-95	ISSUED BY DIRECTOR	APPROVED 	
POLICY REPLACED Yes	POLICY NO D-504-1	PAGE NO. All	DATED 2-22-94

**POLICY**

ALL HERBICIDES USED BY THE DEPARTMENT SHALL BE PROPERLY LABELED FOR USE ON PUBLIC RIGHTS-OF-WAY, AND SHALL BE APPLIED BY A CERTIFIED APPLICATOR.

**Definition:**

The Herbicide Program is a systematic, professionally managed application program designed to control noxious and undesirable vegetation along highway rights-of-way, and enhance the growth of Bermuda and other desirable grasses that result in a safe and aesthetically pleasing roadway, properly protected from the effects of erosion.


**Assignment of Responsibility:**

The Herbicide Program will be managed under the direction of the Maintenance Division and the Oklahoma State University Extension Service. Each Field Division Engineer will bear the primary responsibility in his/her respective Divisions.

**Implementation (Specifics):**

- I. Certification - All applicators of herbicides to be applied upon highway rights-of-way will be by the Oklahoma State Department of Agriculture in Category Six (6) and will work under a license secured by O.D.O.T.



OKLAHOMA DEPARTMENT OF TRANSPORTATION			
POLICY DIRECTIVE			NO. D-504-1
SUBJECT HERBICIDE PROGRAM		PAGE NO. 2 OF 2	DATED 8-01-95
EFFECTIVE DATE 8-01-95	ISSUED BY DIRECTOR	APPROVED 	
POLICY REPLACED Yes	POLICY NO. D-504-1	PAGE NO. All	DATED 2-22-94

- II. Training - All employees involved with the application of herbicides are to attend yearly continuing education courses that keep them current with new right-of-way management information. The Department of Agriculture requires this yearly training in order to keep certification without retesting. This yearly training is currently being taught by the Oklahoma Cooperative Extension Service.
- III. Application specifics - When applying herbicides, the average wind speed shall be less than 16 kph (10 mph). All application rates shall not exceed the maximums as recommended by Oklahoma State University and the manufacturers label or labeling information and shall not exceed 206.84 kpa (30 psi) when making broadcast applications with a solid stream nozzle and shall not exceed 172.375 kpa (25 psi) when making broadcast applications with a fan type nozzle. A drift retardant or drift control agent shall be used with any chemical being applied except when being applied by a small capacity hand pump (1-5 gallon) sprayer. When utilizing a handgun-type application method, follow herbicide label instruction for appropriate application pressures.

## **4.7 RECORD KEEPING**

It is the responsibility of each ODOT applicator to keep accurate records of all pesticide (or herbicide) applications as required by the Oklahoma Pesticide Applicator's Law. These records shall be kept at the respective division headquarters or county/interstate field office for a minimum of two (2) years. A pesticide application record sheet (Figure 4.4) has been developed for ODOT. A separate record sheet should be filled out for each tank load of herbicide which is sprayed along with a copy of each herbicide label used. Whether it's a large 1300 gallon load or a small 3 gallon backpack each individual load requires its own separate record. Some information such as time, wind speed and direction, and location of the treated area will change between each tank load, therefore, this change needs to be recorded for possible future reference. The State Board of Agriculture through the Oklahoma Department of Agriculture, Food, and Forestry (ODAFFF) has the authority to examine these records upon request. Also, don't forget about the new EPA Endangered Species Protection Bulletin records that must now accompany annual herbicide records. These records are covered in detail in Section 12.1.1 of these guidelines.

**Figure 4.4.** Oklahoma Department of Transportation Pesticide Application Record.

Date: \_\_\_\_\_ State and End Time: \_\_\_\_\_  
Location: \_\_\_\_\_  
Approximate Acres Treated: \_\_\_\_\_  
Pesticide(s) Applied: \_\_\_\_\_ Gallons of Mixture: \_\_\_\_\_  
Trade Name(s): \_\_\_\_\_  
Manufacturer(s): \_\_\_\_\_  
Concentration: \_\_\_\_\_  
Type of Applicator: \_\_\_\_\_  
Rate of Application: \_\_\_\_\_  
Rate of Carrier: \_\_\_\_\_ gpa (Water; Oil)  
Target Species: \_\_\_\_\_  
Wind Velocity: \_\_\_\_\_ Direction: \_\_\_\_\_  
Temperature: \_\_\_\_\_  
Weather: \_\_\_\_\_  
EPA Reg. No. \_\_\_\_\_  
EPA Est. No. \_\_\_\_\_  
Restricted Entry Internal from Label: \_\_\_\_\_

\_\_\_\_\_  
Applicator(s)

\_\_\_\_\_  
County Foreman

\_\_\_\_\_  
ODOT Facility

NOTES:  
Division Office - 1 copy  
File - 1 copy  
Form M-51  
4-1-79

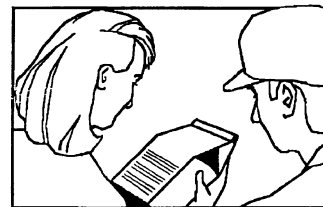
## 4.8 HERBICIDE COMPLAINT PROCEDURES

No matter how positive the results are from an ODOT herbicide program there may always be a few landowners who do not like the idea of herbicides being applied to adjacent land. These landowners are usually not bashful about sharing their opinions and make yearly complaints when ODOT spray crews are spotted on the highway. There are also times when even the most conscientious of spray crews may get a little aggressive and either directly spray or allow drift onto a sensitive area, thus creating a very legitimate complaint for the landowner. Whether a complaint is justifiable or unjustifiable, they have and will continue to occur. Complaints are part of an herbicide program. Whether these complaints are formal (filed with the ODAFF) or informal (made only to ODOT personnel), to maintain a professional IRVM program, the complaints should be dealt with promptly and very seriously.

The recommended procedures for handling any complaint, formal or informal, are covered in Chapter 13. Never ignore an herbicide complaint. This is an area in which the “Golden Rule” definitely applies.

## 4.9 HERBICIDE LABELS

An herbicide label is considered a legal document which contains information that is printed on or attached to the herbicide container. Herbicides handled or used in a careless manner can endanger the health of the applicator, other people, animals, plants or the environment. The herbicide label provides valuable information about proper handling and use of the



herbicide, potential risks that the herbicide may pose and instructions on how to avoid or minimize these risks. It is the legal responsibility of the applicator to read, understand and follow the label information and directions correctly in their entirety so that no harm will result from the use or handling of herbicides. The herbicide label should be read at several critical times to insure the expected benefits are realized and that potential problems are prevented.

Read the herbicide label before buying an herbicide to determine\*:

1. If the herbicide will control the targeted weed or weeds.
2. If the herbicide can be applied safely and legally under the application conditions.
3. Where the herbicide can and cannot be applied.
4. The required application and safety equipment.
5. Relevant restrictions for use of the herbicide.

\*For most situations, ODOT applicators will not usually have the actual responsibility of purchasing herbicides.

Read the herbicide label before mixing the herbicide to determine:

1. The proper personal protective equipment which should be used.
2. Incompatibility or compatibility of the herbicide with other herbicides or adjuvants.
3. Proper amount of the herbicide to use.
4. Proper mixing procedure.

Read the label before applying the herbicide to determine:

1. The proper safety measures which should be followed.
2. When to apply the herbicide.
3. How to apply the herbicide.
4. The proper procedures to minimize potential problems to people, animals, plants or the environment.

Read the herbicide label before storing or disposal of the herbicide container to determine:

1. Where and how to properly store the herbicide. Extreme air temperatures (cold or hot) may affect the chemical activity of the herbicide ingredient(s).
2. The proper means of disposing of the herbicide container.

\*Refer to Sections 12.2.4 and 12.2.5 for further information and details.

# **CHAPTER 5.0 SUGGESTED HERBICIDE TREATMENTS FOR ROADSIDE WEED PROBLEMS**

## **5.01 PURPOSE**

This purpose of this chapter is to summarize suggested herbicides, surfactants, rates of application, water carrier rates, timing of application, and important comments for products that have met the ODOT Approved Herbicide and Adjuvant List (AHAL) Program criteria (refer to Chapter 14 for AHAL information).

## **5.05 INTRODUCTION**

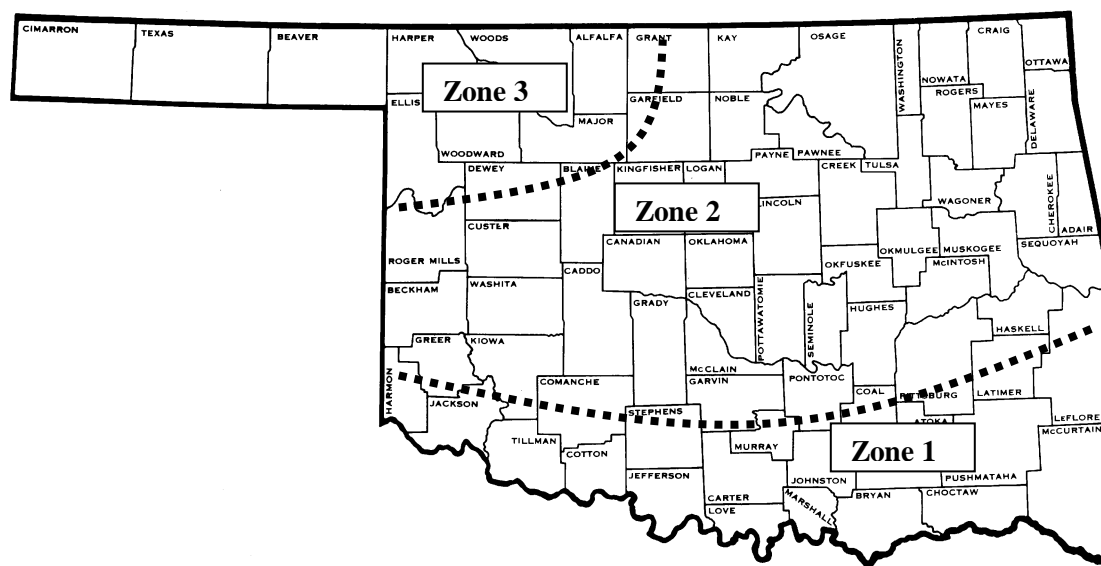
Right-of-way vegetation management is a very important part of the overall roadside maintenance program. The vegetation adjacent to the road surface is a functional part of the road. In addition to mechanical methods, herbicides are used for managing right-of-way vegetation. When used correctly, herbicides can selectively control undesirable weeds and leave nearby beneficial plants unharmed.

The herbicide suggestions in this chapter are the same as those found in OSU Circular E-958 (October 2008). Any and all of these products can be found on the current ODOT AHAL (Chapter 14). All of the following suggestions are in compliance with the products' US EPA and State approved labels. These suggestions have been developed through cooperative research projects with Oklahoma State University. These research projects involved trials conducted to provide ODOT with specific herbicide suggestions for both effective and efficient herbicide programs. Some of the suggestions have a range of use rates listed. Each field division should select a specific rate within this range of rates, or consult the roadside vegetation management team at

OSU for specific suggestions. Any deviation from these suggestions is discouraged unless directly suggested by OSU through further consultation.

There may be times when isolated weed problems arise for which no formal suggestion has been developed. Under these circumstances the roadside vegetation management team at OSU should be consulted for appropriate suggestions.

The remainder of this chapter is devoted to specific suggestions for weed control on Oklahoma roadsides. Suggested timings of herbicide applications for managing weed problems are shown in Figure 5.1. Commonly used herbicide products, active ingredients and companies' marketing these products are shown in Table 5.1.



**Figure 5.1.** Seasonal Herbicide Spray Zones Along Oklahoma Roadsides. Seasonal Spray Zones Are Based On Many Factors. Optimize Your Weed Control Results By Following The Suggested Treatment Dates For Your Specific Zone.



**Table 5.1.** Trade Names, Active Ingredients and Companies That Market Commonly Used Herbicides in Oklahoma Roadside Vegetation Management and That Are Found on the Approved Herbicide and Adjuvant List as of May 2009<sup>1</sup>.

<b>Trade Name</b>	<b>Active Ingredient(s) or Common Name</b>	<b>Company</b>
Campaign <sup>®</sup>	glyphosate + 2,4-D	Monsanto Agricultural Company
Diuron 80 WDG <sup>®</sup>	diuron	Loveland Industries, Inc.
Garlon 4 Ultra <sup>®</sup>	triclopyr	Dow AgroSciences
Aquamaster, Aqua Star	glyphosate (aquatic)	Monsanto and many companies
Honcho, Honcho Plus, Mirage, Mirage Plus, Ranger Pro	glyphosate	Monsanto and many companies
Habitat <sup>®</sup>	imazapyr (aquatic)	BASF
Arsenal, Imazapyr 25L	imazapyr	BASF and many companies
Krenite S <sup>®</sup>	fosamine	Dupont
Escort XP, MSM E-Pro, Metsulfuron Methyl	metsulfuron methyl	Dupont and many companies
Milestone VM <sup>®</sup>	aminopyralid	Dow AgroSciences
MSMA	MSMA	many companies
Oust XP, SFM-75, SFM E-Pro	sulfometuron	Dupont and many companies
Outrider <sup>®</sup>	sulfosulfuron	Monsanto Agricultural Company
Overdrive <sup>®</sup>	dicamba + diflufenzopyr	BASF
Plateau <sup>®</sup>	imazapic	BASF
Roundup Pro Concentrate <sup>®</sup>	glyphosate	Monsanto Agricultural Company
Tordon K <sup>®2</sup>	pictogram	Dow AgroSciences
Transline <sup>®</sup>	clopyralid	Dow AgroSciences
Vanquish <sup>®</sup>	diglycolamine salt of dicamba	Nufarm/Syngenta

<sup>1</sup>The Approved Herbicide and Adjuvant List (AHAL) can be found in Chapter 14 of the *2009 Edition of the Oklahoma Roadside Vegetation Management Guidelines*.

<sup>2</sup>Restricted use herbicide.

## 5.1 JOHNSONGRASS CONTROL USING POSTEMERGENCE HERBICIDES

### 5.1.1 Herbicide: **glyphosate + sulfometuron**

Rate: 16 to 24 fluid ounces of product + 1 ounce of product respectively

Carrier: 20 to 40 gallons of water per acre

Time of Application: Zone 1: April 20 - May 31;  
Zone 2: May 10 - June 15;  
Zone 3: May 20 - June 30.

#### Comments:

1. If Roundup Pro Concentrate<sup>®</sup> is used, apply 13 to 19 fluid ounces of product per acre.
2. Application should be made after bermudagrass has broken dormancy and is 100% green and actively growing.
3. Add glyphosate to the tank mixture first and then add the sulfometuron.
4. Applications should not be made to areas that have little or no bermudagrass to release. It is recommended that a roadside needs at least 30% bermudagrass cover. If not, use a MSMA program until you achieve recommended coverage.
5. Applications should not be made on newly sprigged or seeded areas. This treatment will slow the rate of coverage from sprigs and inhibit seed germination.
6. Do not apply to saturated soils or if rainfall will occur within 2 to 6 hours. Rainfall will wash the glyphosate from the plants and reduce the level of control. Generic glyphosates need to remain on foliage for at least 6 hours before any significant rainfall event.
7. Glyphosate rates higher than 16 fluid ounces of product per acre should not be used in the western one-third of Oklahoma.
8. Do not mow roadsides prior to treatment. Wait at least 10 days after treatment before mowing or weed control may be reduced.

**5.1.2 Herbicide: glyphosate + Plateau®**

Rate: 12 to 16 fluid ounces of product + 4 fluid ounces of product per acre, respectively

Carrier: 20 to 40 gallons of water per acre

Time of Application: Zone 1: April 20 - May 31;

Zone 2: May 20 - June 15;

Zone 3: May 20 - June 30.

Comments:

1. If Roundup Pro Concentrate® is used, apply 10 to 13 fluid ounces of product per acre.
2. Application should be made after bermudagrass has broken dormancy and is 100% green and actively growing.
3. Add glyphosate to the tank mixture first, and then add the Plateau®.
4. Plateau is available only through direct purchase from the manufacturer (BASF).
5. Applications should not be made to areas that have little or no bermudagrass to release. It is recommended that a roadside needs at least 30% bermudagrass cover. If not, use a MSMA program until you achieve this recommended coverage.
6. Applications should not be made on newly sprigged or seeded areas. This treatment will slow the rate of coverage from sprigs and inhibit seed germination.
7. Do not apply to saturated soils or if rainfall will occur within 2 to 6 hours. Rainfall will wash the glyphosate from the plants and reduce the level of control. Generic glyphosates need at least 6 hours before any significant rainfall event.
8. Do not mow roadsides prior to treatment. Wait at least 10 days after treatment before mowing or weed control may be reduced.
9. Plateau will provide residual control of summer annual grassy weeds like crabgrass, sandbur, and others.

**5.1.3 Herbicide: glyphosate + Outrider®.**

Rate: 12 to 24 fluid ounces of product + 0.75 to 1.33 ounces of product per acre, respectively

Carrier: 20 to 40 gallons of water per acre

Time of Application: Zone 1: April 20 - May 30;

Zone 2: May 10 - July 20;

Zone 3: May 20 - Aug 15.

Comments:

1. If Roundup Pro Concentrate® is used, apply 10 to 19 fluid ounces of product per acre.
2. This treatment will produce less noticeable injury to bermudagrass. It has the greatest level of bermudagrass safety of any of the suggested johnsongrass treatments especially at later applications.
3. Application should be made after bermudagrass has broken dormancy and is 100% green and actively growing.
4. Add glyphosate to the tank mixture first and then add the Outrider®.
5. Applications should not be made to areas that have little or no bermudagrass to release. It is recommended that a roadside needs at least 30% bermudagrass cover. If not, use a MSMA program until you achieve recommended coverage.
6. Applications should not be made on newly sprigged or seeded areas. This treatment will slow the rate of coverage from sprigs and inhibit seed germination.
7. Do not apply to saturated soils or if rainfall will occur within 2 to 6 hours. Rainfall will wash the glyphosate from the plants and reduce the level of control. Generic glyphosates need to remain on foliage for at least 6 hours before any significant rainfall event.
8. After mowing wait until johnsongrass has 12 to 24 inches of regrowth before treating. Wait at least 10 days after treatment before mowing or weed control may be reduced.
9. The addition of certain amine-form broadleaf weed control herbicides to this treatment can result in reducing johnsongrass control (antagonism). This is not desirable and one should consult the Outrider® label before tank-mixing.
10. Glyphosate rates higher than 16 fluid ounces of product per acre should not be used in the western one-third of Oklahoma.

#### 5.1.4 Herbicide: **MSMA**

Rate: 2 to 3 pounds of active ingredient per acre

Carrier: 40 gallons of water per acre

Time of Application: Zone 1: April 15 - July 30;

Zone 2: May 10 - Aug 15;

Zone 3: May 20 - Aug 15.

#### Comments:

1. Two or three applications per year will be required to control johnsongrass. Treatments should start when johnsongrass reaches 12 to 18 inches in height and retreatments should be made when regrowth is 12 to 18 inches tall (retreatments usually will be made on a 3 to 4 week interval maximum).
2. Preemergence seedling johnsongrass control may be achieved by adding sulfometuron or Outrider<sup>®</sup> at 1 ounce product per acre when the first MSMA treatment is made. Do not add sulfometuron or Outrider<sup>®</sup> to subsequent MSMA treatments.
3. Never apply MSMA to standing water, creeks, rivers or ponds. Be sure to shut off spray rigs when passing over bridges.
4. MSMA, alone, can be used on newly sprigged or thin roadsides, as MSMA will produce very little injury or slow bermudagrass growth and development.
5. MSMA should not be applied to young bermudagrass seedlings until they have produced stolons from 1 to 3 inches in length.

## 5.2 WINTER ANNUAL GRASSES AND BROADLEAF WEED CONTROL USING POSTEMERGENCE HERBICIDES

### 5.2.1 Herbicide: Campaign<sup>®</sup> + Ammonium Sulfate (AMS)

- Rate: 2 to 4 pints of product per acre + 17 pounds of product per 100 gallons of carrier (AMS is used only with low end rates of Campaign<sup>®</sup>)
- Carrier: 20 to 40 gallons of water per acre
- Time of Application: Zone 1: Feb 15 - March 20;  
Zone 2: Feb 25 - March 31;  
Zone 3: Mach 10 - April 15.

#### Comments:

1. Apply to dormant bermudagrass. Applications made to bermudagrass that is beginning to green-up will result in temporary discoloration and slight bermudagrass green-up delay.
2. Campaign<sup>®</sup> should be applied alone at a rate of 3 to 4 pints of product per acre alone. Campaign<sup>®</sup> applied at 2 pints product per acre requires the addition of AMS. The AMS will significantly reduce treatment costs while maintaining weed control.
3. Targeted weeds must be actively growing and may take 2 to 3 weeks before showing any phytotoxicity symptoms from the herbicides (this is because of the cool temperatures).
4. This product is for the control of emerged weeds only, there is no preemergence control of weeds with this treatment.
5. Precautions should be taken to avoid drift to susceptible non-target plants.
6. AMS should be mixed thoroughly into the tank first, then add the Campaign<sup>®</sup>.
7. This treatment needs to be applied before targeted weeds reach 6 inches tall to assure good coverage and control.
8. Roadsides that are infested with musk thistle would benefit from an addition of Overdrive<sup>®</sup> at 2 ounces per acre.
9. The addition of Milestone VM<sup>®</sup> at 4 ounces product per acre to this treatment would provide 3 to 5 months of summer annual broadleaf weed control.

## 5.3 ANNUAL RYEGRASS CONTROL USING POSTEMERGENCE HERBICIDES

### 5.3.1 Herbicide: Campaign<sup>®</sup> + glyphosate + Ammonium Sulfate (AMS)

Rate: 2 pints product + 16 fluid ounces of product per acre + 17 pounds of product per 100 gallons of carrier

Carrier: 20 to 40 gallons of water per acre

Time of Application: Zone 1: Feb 15 - March 10;  
Zone 2: Feb 20 - March 25;  
Zone 3: Mach 5 - April 5.

#### Comments:

1. If Roundup Pro Concentrate<sup>®</sup> is used apply at 13 fluid ounces of product per acre.
2. This treatment should only be substituted for a traditional Campaign<sup>®</sup> program when annual ryegrass becomes a problem in the clear zone.
3. Annual ryegrass requires higher herbicide rates to achieve successful control.
4. Apply to dormant bermudagrass. Applications made to bermudagrass that is beginning to green-up will result in temporary discoloration and slight bermudagrass green-up delay.
5. Targeted weeds must be actively growing and may take 2 to 3 weeks before showing any phytotoxicity symptoms from the herbicides (this is because of the cool temperatures).
6. This product is for the control of emerged weeds only, there is no preemergent (residual) control of weeds with this treatment. Milestone VM<sup>®</sup> at 4 ounces product per acre may be added to this treatment to provide 3 to 5 months of summer annual broadleaf weed control.
7. Precautions should be taken to avoid drift to susceptible non-target plants.
8. This treatment needs to be applied before targeted weeds reach 6 inches tall to assure good coverage and control.

### 5.3.2 Herbicide: **glyphosate**

Rate: 32 fluid ounces of product per acre

Carrier: 20 to 40 gallons of water per acre

Time of Application: Zone 1: Feb 15 - March 10;

Zone 2: Feb 20 - March 25;

Zone 3: Mach 5 - April 5.

#### Comments:

1. If Roundup Pro Concentrate<sup>®</sup> is used apply at 25 fluid ounces of product per acre.
2. This treatment should only be substituted for a traditional Campaign<sup>®</sup> program when annual ryegrass becomes a problem in the clear zone.
3. Annual ryegrass requires higher herbicide rates to achieve successful control.
4. Apply to dormant bermudagrass. Applications made to bermudagrass that is beginning to green-up will result in temporary discoloration and slight bermudagrass green-up delay.
5. Targeted weeds must be actively growing and may take 2 to 3 weeks before showing any phytotoxicity symptoms from the herbicides (this is because of the cool temperatures).
6. This product is for the control of emerged weeds only, there is no preemergence control of weeds with this treatment. Milestone VM<sup>®</sup> at 4 ounces product per acre may be added to this treatment to provide 3 to 5 months of summer annual broadleaf weed control.
7. Precautions should be taken to avoid drift to susceptible non-target plants.
8. This treatment needs to be applied before targeted weeds reach 6 inches tall to assure good coverage and control.



## 5.4 EARLY PREEMERGENCE AND POSTEMERGENCE CONTROL OF WINTER AND SUMMER BROADLEAF WEEDS

### 5.4.1 Herbicide: Milestone VM<sup>®</sup> + non-ionic surfactant

Rate: 4 ounces of product per acre + 0.25 percent solution

Carrier: 20 to 40 gallons of water per acre

Time of Application: Zone 1: Feb 15 - March 10;

Zone 2: Feb 25 - March 31;

Zone 3: Mach 5 - April 5.

#### Comments:

1. This treatment can be tank-mixed with any of the Winter Annual Weed Control Treatments to add a residual component.
2. This treatment produces good postemergence control of emerged winter broadleaf weeds and provides 4 to 5 months of residual control of many common summer annual broadleaf weeds.
3. This treatment will provide 40 to 50 percent kochia suppression if applied and activated with rainfall before kochia emerges.
4. A quality non-ionic surfactant should be used that has a minimum of 80 percent active ingredient if used alone.
5. Precautions should be taken to avoid drift to susceptible non-target plants.
6. This product can provide summer broadleaf weed control from March applications. This reduces potential to damage broadleaf crops that are planted after April or May. It reduces the need for summer applications of Vanquish<sup>®</sup> to control broadleaf weeds.

**5.4.2 Herbicide: Diuron 80 WDG® + non-ionic surfactant**

Rate: 3 to 5 pounds product per acre + 0.25 percent solution

Carrier: 25 to 40 gallons of water per acre

Time of Application: Zone 1, 2, and 3: January 15 – February.

Comments:

1. Diuron 80 WDG® is used primarily in areas infested with kochia.
2. This suggestion is specific to the Diuron 80 WDG® Loveland Industries product as it is currently labeled for recommended rates.
3. A quality non-ionic surfactant should be used that has a minimum of 80 percent active ingredient if used alone.
4. Application should be made on completely dormant bermudagrass.
5. Applications should never be made to saturated or frozen soils (there is a potential for runoff if application is followed by rain).
6. Regardless of right-of-way width, always leave an untreated buffer zone.
7. Diuron 80 WDG® can be used with imazapyr or glyphosate treatments to provide long-term total vegetation control around signs and guardrails.

## 5.5 GENERAL BROADLEAF WEED CONTROL USING POSTEMERGENCE HERBICIDES

### 5.5.1 Herbicide: **Vanquish<sup>®</sup> + non-ionic surfactant**

Rate: 1 to 2 pints of product per acre + 0.25 percent solution, respectively

Carrier: 20 to 40 gallons of water per acre as a broadcast application or 50 to 100 gallons per acre as a handgun or backpack application

Time of Application: Zone 1, 2, and 3: March 15 – June 30.

#### Comments:

1. A quality non-ionic surfactant should be used that has a minimum of 80% active ingredient.
2. Precautions should be taken to avoid drift to susceptible crops. This herbicide can volatilize at higher air temperatures.
3. One timely application per year should control most broadleaf weeds including kochia.
4. Because of different carrier rates, a single tank mixture should not be used for both broadcast and handgun applications. This could cause a severe over or under application of targeted herbicide rates.
5. Vanquish<sup>®</sup> should provide good broad spectrum broadleaf weed control, however, refer to label for specific weed species.
6. Better control can be achieved by treating smaller seedlings or early vegetative stage weeds that are no taller than 3 inches.
7. For best results on biennial weeds, applications should be made to rosettes or at the early vegetative stage when plants are no taller than 6 inches.
8. This treatment is also very effective at controlling the state noxious weed, scotch thistle when applied in March through April.

## 5.6 MUSK THISTLE CONTROL USING POSTEMERGENCE HERBICIDES

### 5.5.1 Herbicide: **Overdrive<sup>®</sup> + non-ionic surfactant.**

Rate: 2 to 4 ounces of product per acre + 0.25 percent solution

Carrier: 20 to 40 gallons of water per acre or 50 to 100 gallons per acre as a as a handgun or backpack application

Time of Application: Zone 1, 2, and 3: March – May 10.

#### Comments:

1. Currently, this is the most economical treatment for controlling musk thistle.
2. Rates less than 4 ounces per acre are made under a new 2ee label and are approved for ODOT and pasture use only. The 2ee label must be in possession during the applications. Applications at 2 ounces per acre must be made to rosette stage of growth, poor control will result if applied to bolted (flowered) thistles at this rate.
3. A quality non-ionic surfactant should be used that has a minimum of 80% active ingredient if used alone.
4. Due to different carrier rates, a single tank mixture should not be used for both broadcast and handgun applications. This could cause a severe over or under application of targeted rates.
5. Applications should be made to actively growing thistles prior to bolting.
6. Extreme growing conditions such as drought or near freezing temperatures prior to, at, and following time of application may reduce thistle control.
7. Precautions should be taken to avoid drift to susceptible non-target plants. This herbicide can volatilize at higher air temperatures.
8. By law (Oklahoma Noxious Weed Law), musk thistles must be prevented from flowering statewide.
9. The 2 ounces per acre rate makes an excellent tank-mix partner with Campaign<sup>®</sup> + AMS at recommended rates to control musk thistle.

**5.6.2 Herbicide: Transline® + non-ionic surfactant.**

Rate: 6 to 10 fluid ounces of product per acre + 0.25 percent solution

Carrier: 20 to 40 gallons of water per acre as a broadcast application or  
50 to 100 gallons of water per acre as a handgun or backpack  
application

Time of Application: Zone 1, 2, and 3: March – May 10.

Comments:

1. A quality non-ionic surfactant should be used that has a minimum of 80% active ingredient.
2. Due to different carrier rates, a single tank mixture should not be used for both broadcast and handgun applications. This could cause a severe over or under application of targeted rates.
3. Applications should be made to actively growing thistles prior to bolting. The lower rate can be used when treating the rosette stage.
4. Extreme growing conditions such as drought or near freezing temperatures prior to, at, and following time of application may reduce thistle control.
5. Precautions should be taken to avoid drift to susceptible non-target plants.
6. By law (Oklahoma Noxious Weed Law), musk thistles must be prevented from flowering statewide.

## 5.7 SCOTCH THISTLE CONTROL USING POSTEMERGENCE HERBICIDES

### 5.7.1 Herbicide: **Metsulfuron methyl + non-ionic surfactant.**

Rate: 1 ounce of product per acre + 0.25 percent solution

Carrier: 20 to 40 gallons of water per acre broadcast application or  
50 to 100 gallons per acre as a handgun or backpack application

Time of Application: Zone 1, 2, and 3: March – April.

#### Comments:

1. A quality non-ionic surfactant should be used that has a minimum of 80% active ingredient.
2. Due to different carrier rates, a single tank mixture should not be used for both broadcast and handgun applications. This could cause a severe over or under application of targeted rates.
3. Broadcast applications should be made to rosettes that are 6 inches or smaller in diameter.
4. Poor results will occur if applications are made during drought conditions.
5. Refer to label for other susceptible species.
6. Precautions should be taken to avoid drift to susceptible crops, gardens and non-target areas.
7. By law (Oklahoma Noxious Weed Law), scotch thistle must be prevented from flowering statewide.

## 5.8 SILVER BLUESTEM CONTROL USING POSTEMERGENCE HERBICIDES

### 5.8.1 Herbicide: **glyphosate**

Rate: 24 fluid ounces of product per acre

Carrier: 20 to 40 gallons of water per acre

Time of Application: Zone 1: April 20 - May 31;

Zone 2: May 10 - June 15;

Zone 3: May 20 - June 30.

#### Comments:

1. If Roundup Pro Concentrate<sup>®</sup> is used, apply 19 fluid ounces of product per acre.
2. Sprayer equipment must be properly calibrated to ensure desirable silver bluestem control and minimize bermudagrass injury.
3. Glyphosate, alone, is used in areas where there is little or no previous history of johnsongrass. In areas where there is a history of johnsongrass, glyphosate + Outrider<sup>®</sup>, sulfometuron or Plateau<sup>®</sup> should be used. If a summer preemergent is not added to the treatment in areas where there are johnsongrass seeds in the soil, the seeds could germinate and create an even bigger problem than the silver bluestem that was controlled. This is because glyphosate has no soil activity.
4. Do not apply glyphosate if rainfall will occur within 2 to 6 hours. Rainfall will wash the glyphosate off the plants and reduce the level of control. Generic glyphosate products need at least 6 hours before a significant rainfall event.
5. Do not mow roadsides prior to treatment. Wait at least 10 days after treatment before mowing or weed control may be reduced.

### 5.8.2 Herbicide: **glyphosate + sulfometuron**

Rate: 24 fluid ounces of product + 1 ounce of product per acre, respectively

Carrier: 20 to 40 gallons of water per acre

Time of Application: Zone 1: April 20 - May 31;

Zone 2: May 10 - June 15;

Zone 3: May 20 - June 30.

#### Comments:

1. If Roundup Pro Concentrate<sup>®</sup> is used, apply at 19 fluid ounces of product per acre.
2. Glyphosate + sulfometuron should be used in areas where there is a past history of johnsongrass problems. If the history of an area is not known, then it is best to add the sulfometuron to the glyphosate treatment. The sulfometuron is soil active and will help prevent johnsongrass seeds from emerging.
3. Spray equipment must be properly calibrated to ensure desirable silver bluestem control and minimal bermudagrass injury.
4. Application should be made after bermudagrass has broken dormancy and is green and actively growing.
5. Add glyphosate to the tank mixture first then add the sulfometuron.
6. Applications should not be made to areas that have little or no bermudagrass to release. It is recommended that a roadside needs at least 30% coverage of bermudagrass, if not, use a MSMA program until this is achieved.
7. Applications should not be made on newly sprigged or seeded areas. This treatment will slow the rate of coverage from sprigs and inhibit seed germination.
8. Do not apply to saturated soils or if rainfall will occur within 2 to 6 hours. Rainfall will wash the glyphosate from the plants and reduce the level of control. Generic glyphosates need at least 6 hours before a significant rainfall event.
9. Do not mow roadsides prior to treatment. Wait at least 10 days after treatment before mowing or weed control may be reduced.
10. This treatment should not be used in the western one-third of Oklahoma. Use glyphosate only treatments to control silver bluestem in western Oklahoma.



## 5.9 SWITCHGRASS MANAGEMENT USING A ROPEWICK OR WIPER APPLICATION

### 5.9.1 Herbicide: **glyphosate**

Rate: 1:2 ratio of herbicide to water

Carrier: Not applicable

Time of Application: Zone 1, 2, and 3: May – June (followed by mowing).

#### Comments:

1. This treatment is to be selectively applied with either a ropewick or wiper-type applicator.
2. An important component of switchgrass management is timely mowings following application. Switchgrass areas should be mowed approximately 1 month and 3 months after treatment. Mowing should occur when switchgrass regrowth begins producing seed heads.
3. Dense stands of switchgrass will require wiping in 2 directions.
4. Do not wipe bermudagrass with this treatment as severe damage will occur.
5. Do not apply to plants which are drought stressed. Wait for a 1/2 to 1 inch rain before making the application.
6. Do not apply if rainfall will occur within 2 to 6 hours. Rainfall will wash glyphosate from the plants and reduce the level of control. Generic glyphosates need at least 6 hours before any significant rainfall event.
7. Do not use drift control products with this treatment.
8. Equipment used should include polyester over acrylic fiber core ropes or canvas and should be cleaned daily with detergent and water. This will remove wax buildup and allow for an even flow of herbicide across the wiping surface.
9. Applications made to plants noticeably covered with dust will result in reduced control.
10. This treatment followed by timely mowings will take a minimum of 2 years to remove switchgrass from safety areas.
11. Do not mow switchgrass areas prior to treatment.
12. Switchgrass should be wiped as low as possible without wiping the bermudagrass.

## 5.10 GENERAL BRUSH CONTROL

### 5.10.1 Herbicide: **Tordon K<sup>®</sup> + Garlon 4 Ultra<sup>®</sup>**

Rate: Refer to labeled rates for specific brush species

Carrier: 50 gallons of water per acre as a broadcast application or a minimum of 100 gallons of water per acre as a handgun application.

Time of Application: Zone 1, 2, and 3: May – July (see comments).

#### Comments:

1. This herbicide treatment can volatilize at higher air temperature.
2. The use of this treatment will cause a very quick brown-out of the brush species in 7 to 14 days. Public acceptance of the treatment should be considered before choosing this treatment.
3. Refer to herbicide labels for susceptible target species. This treatment, applied in early summer to new leaves, should give very good control of most brush species found along Oklahoma roadsides.
4. Handgun applications should be made on a spray-to-wet basis using a minimum of 100 gallons per acre for low-density brush and up to 250 gallons per acre for high-density brush areas.
5. Due to different carrier rates, it is not recommended that a single tank mixture be used for both broadcast and handgun applications. This could cause a severe over or under application of targeted rates.
6. Most brush species are susceptible to this treatment, extreme caution should be used to prevent off-target movement of fine spray particles.
7. Always use a quality drift control additive to reduce the number of fine spray particles. This will help reduce the hazard of off-target drift.
8. Follow label rates for the specific brush species you are targeting.
9. Use extreme caution when treating near any ground water. Leave a buffer zone around all ground water sources.
10. Tordon K<sup>®</sup> is a restricted use herbicide because of its potential to move to groundwater sources.
11. Brush should not be removed following application for a minimum of 1 month.

**5.10.2 Herbicide: Krenite S<sup>®</sup> + crop oil.**

Rate: Refer to the label for specific brush control rates.

Carrier: Apply a minimum of 100 gallons of water per acre as a handgun or broadcast application.

Time of Application: Zone 1, 2, and 3: June – October (see comments).

Comments:

1. Little to no foliage brown-out will occur after treatment. Leaves will drop off the tree in a normal fashion and the following spring the tree will not produce any new leaves.
2. The addition of a crop oil is critical to aid in absorption of the herbicide through the waxy leaves.
3. Handgun applications should be made on a spray-to-wet basis using a minimum of 100 gallons per acre for low-density brush and up to 250 gallons per acre for high-density brush areas.
4. Refer to herbicide label for susceptible species. This treatment does not produce as broad a spectrum of brush control as Tordon K<sup>®</sup> + Garlon 4 Ultra<sup>®</sup>. Identifying problem brush species is very important.
5. Thorough coverage of the entire target plant is necessary for complete control of susceptible species as this treatment has little if any translocation in the treated brush.
6. Do not apply Krenite S<sup>®</sup> if rainfall will occur anytime during the day of application. The Krenite S<sup>®</sup> will be washed off the leaves and reduce the level of control.
7. Applications made in October should be made before fall leaf discoloration.

**5.10.3 Herbicide: glyphosate (foliar spot treatment only)**

Rate: 1.5 gallons of product per acre

Carrier: 100 gallons of water per acre (handgun only).

Time of Application: Zone 1, 2, and 3: June - October.

Comments:

1. If Roundup Pro Concentrate<sup>®</sup> is used, apply at 1.25 gallons of product per acre.
2. Do not make broadcast applications with this treatment. This herbicide treatment will cause severe damage or death of desirable grass understories if applied as a broadcast treatment.
3. This treatment should be applied as a foliar spot treatment using a handgun application only.
4. Apply the herbicide mixture on a spray-to-wet basis.
5. At this rate of application the grass understory will be killed at the base of the spot treatment.
6. Do not apply glyphosate if rainfall will occur within 2 to 6 hours. Rainfall will wash the glyphosate off the plant and reduce the level of control. Generics require 6 hours before they are rainfast.
7. Refer to the herbicide label for susceptible target species.
8. This treatment should only be used on low density brush areas.

## 5.11 BRUSH CONTROL USING CUT SURFACE TREATMENTS

### 5.11.1 Herbicide: glyphosate (cut stump treatments only)

Rate/Carrier: 1:1 water to herbicide ratio

Time of Application: Zone 1, 2, and 3: May – September.

#### Comments:

1. All brush manually cut by Oklahoma Department of Transportation crews and not previously treated with a herbicide should receive a cut stump treatment to prevent resprouting.
2. Applications should be made immediately after cutting or as soon as possible. Delay in application of more than 30 minutes may result in reduced performance on hard-to-control species.
3. Apply using a backpack sprayer or squirt bottle.
4. Remove wood chips from the stump before application. It is only necessary to treat the outside 1/3 of the top of the cut stump as this is where the cambium layer is found. The cambium will move the herbicide to the roots. Treat the entire circumference of the cut surface.
5. It would be useful to include an agricultural dye in this treatment to prevent waste and mark treated stumps. Use water soluble dyes with glyphosate and oil soluble dyes with Garlon 4 Ultra<sup>®</sup>.
6. No drift control product should be used with this treatment.
7. The Garlon 4 Ultra<sup>®</sup> + oil carrier treatment (low volume dormant basal) should be used in the dormant season instead of glyphosate.

## 5.12 BRUSH CONTROL USING DORMANT BASAL STEM AND/OR CUT SURFACE TREATMENTS

### 5.12.1 Herbicide: **Garlon 4 Ultra<sup>®</sup> + oil carrier.**

Rate: 4:1 oil to herbicide ratio (low volume dormant basal and cut surface)

20:1 oil to herbicide ratio (high volume dormant basal)

Time of Application: Zone 1, 2, and 3: Year-round, especially during the winter dormant season.

#### Comments:

1. Low volume applications are made by lightly spraying the cambium area (outside 1/3 of the top of the cut surface) or entire circumference of the trunk (dormant basal) to the point of wetting but not runoff. This treatment usually requires the additional purchase of very small nozzle tips that will produce a fine spray. This low volume solution is very concentrated, if runoff occurs the expensive herbicide is wasted.
2. High volume applications are made by spraying the entire circumference of the trunk (dormant basal) to the point where the mixture is allowed to runoff and pool at the base of the target for a few seconds. Most backpack or small hand-pump sprayers when purchased have nozzle tips designed to make this type of treatment.
3. High volume (20:1 oil to herbicide) mixtures should not be used for cut surface applications.
4. It is critical that the entire cambium area (cut surface) or entire circumference of the trunk (dormant basal) is treated to ensure complete control no matter what ratio of oil to herbicide is used. Failure to get good coverage will result in possible resprouting.
5. Dormant basal stem treatments should be made to trees with stems 6 inches or less in diameter.
6. Trunks that are 0 to 3 inches in diameter should be treated to a height of 18 inches. Trunks larger than 3 inches in diameter should be treated to a height of 24 inches.
7. The addition of an oil soluble dye may assist in getting the desired coverage from these treatments as well as marking treated areas.
8. Backpack or small hand sprayers would work well for these treatments but it is important to only use ones that have Viton seals. Garlon 4 Ultra<sup>®</sup> will cause rubber or pvc seals to leak.
9. Applications may be made up to the edge of water but may not be applied to brush in water.
10. No drift control product should be used with this treatment.
11. This treatment should be mixed with a penetrating oil as a carrier and should never be mixed with water as a carrier.

## 5.13 BERMUDAGRASS ENCROACHMENT CONTROL USING POSTEMERGENCE HERBICIDES

### 5.13.1 Herbicide: **imazapyr + non-ionic surfactant**

Rate: 4 pints of produce per ace + 0.5 percent solution, respectively

Carrier: 40 gallons of water per acre

Time of Application: Zone 1: April 25 - Sept 15;

Zone 2: May 10 - Sept 15;

Zone 3: May 20 – Sept 15.

#### Comments:

1. Application is to be made to 100% green and actively growing bermudagrass.
2. This treatment should only be applied once per year.
3. In areas that have not been treated with glyphosate plus a summer preemergence, a herbicide such as sulfometuron or diuron should be added to control weeds that germinate from seed.
4. Do not apply directly to water or wetlands.
5. Do not treat irrigation ditches.
6. Do not apply, drain or flush equipment on or near desirable trees or other plants; onto areas into which their roots may extend; or locations where the chemical may be washed or moved into contact with their roots or into water features.

## **5.14 AQUATIC WEED CONTROL IN STANDING OR MOVING WATER (CATTAIL, WILLOW, COTTONWOOD)**

### **5.14.1 Herbicide: glyphosate (aquatic) + non-ionic surfactant**

Rate: 1 percent solution + 1 percent solution, respectively

Carrier: 100 gallons of water per acre (handgun treatment only).

Time of Application: Zone 1, 2, and 3: May 15 – August.

#### Comments:

1. A non-ionic aquatic-approved surfactant is critical to the success of this herbicide treatment.
2. If the low end glyphosate rate is used then use the high end non-ionic surfactant rate.
3. Apply with a handgun or backpack sprayer only. This treatment should not be made as a broadcast application as the desirable grass understory may be damaged or destroyed.
4. In dense stands of willow or cattails, good coverage is critical. Plants should be treated from both sides if possible.
5. Plants that have not emerged at the time of treatment will not be controlled and they will require retreatment.
6. Do not apply if rainfall will occur within 2 to 6 hours. Rainfall will wash glyphosate from the plants and reduce control.



#### **5.14.2 Herbicide: Habitat<sup>®</sup> + aquatic-approved non-ionic surfactant or methlated seed oil**

Rate: 1 percent solution + 1 percent solution, respectively

Carrier: 20 to 100 gallons of water per acre (handgun treatment only)

Time of Application: Zone 1, 2, and 3: May – July.

##### Comments:

1. This is the best treatment for long-term cattail control.
2. A non-ionic aquatic-approved surfactant or methylated seed oil is critical to the success of this herbicide treatment.
3. When a low volume carrier rate is used target vegetation should receive approximately 70% coverage. Low volume applications are made with backpack sprayers equipped with small fan-type spray tips. The high volume carrier rate is a spray-to-wet application and is typically achieved with larger spray tips and powered handguns.
4. Apply with a handgun or backpack sprayer only. This treatment should not be made as a broadcast application as the desirable grass understory may be damaged or destroyed.
5. Refer to label for restrictions on treating irrigation ditches and in the vicinity of potable water intakes.
6. Plants that have not emerged or are underwater at the time of treatment will not be controlled.
7. This treatment is very slow to produce brown-out of target vegetation, it may take up to 12 weeks for final brown-out. Be patient, the final results should be very good through 1 year-after-treatment.

## 5.15 POSTEMERGENCE TOTAL VEGETATION CONTROL UNDER CABLE-BARRIER SYSTEMS

### 5.15.1 Herbicide: **glyphosate**

Rate: 1 to 5 quarts of product per acre or handgun 1 – 2% solution  
(spray-to-wet)

Carrier: 20 to 40 gallons of water per acre or handgun 100 gallons per acre

Time of Application: Zone 1, Zone 2, and Zone 3: May 1 – September 1.

#### Comments:

1. If Roundup Pro Concentrate<sup>®</sup> is used, apply 0.8 to 4.0 quarts of product per acre broadcast or 0.8 to 1.6% solution by handgun.
2. This treatment will control vegetation that is present on the day of application. This treatment will not provide long-term residual control and may be safely applied to ditch bottoms.
3. Use the low end rate (1 qt/A or 1% solution) to treat under cable-barrier systems that are infested with winter and/or summer annual weeds only (no perennial weeds present).
4. Use the higher end rate (5 qt/A or 2% solution) to treat under cable-barrier systems that are infested with annual weeds and perennial weeds.
5. Do not apply if rainfall will occur within 2 to 6 hours. Rainfall will wash glyphosate from the plants and reduce control.
6. Areas treated in May to July will likely require 1 to 2 retreatments to maintain total vegetation control under the cable-barrier for the entire growing season.
7. Applications of higher rates should only be made to the gravel or hard surfaces underneath cable-barrier systems and not adjacent soils. Applications of higher rates outside of this zone could promote soil erosion around cable-barrier edges.

## **CHAPTER 6.0 HERBICIDE ADJUVANTS**

### **6.01 PURPOSE**

The purpose of this chapter is to provide information on spray adjuvants, their proper use, and compatibility with herbicides. These products will have met the ODOT Approved Herbicide and Adjuvant List (AHAL) Program criteria (refer to Chapter 14 for AHAL information).

### **6.05 INTRODUCTION**

An adjuvant is any material which is added to an herbicide formulation or to an herbicide spray tank mixture to modify or increase the effectiveness or performance of the mixture. Adjuvants such as surfactants and drift control products are very important to ODOT. Proper use of surfactants allows for lower herbicide use rates to be used while drift control products help minimize drift issues. The discussion contained within this manual will be limited to the types of products which are added separately to the spray tank mixture prior to application. These product types include drift control products (Section 6.3), surfactants (Section 6.4), crop oils (Section 6.5), and ammonium sulfate (Section 6.6).

## **6.1 ODOT DRIFT CONTROL POLICY**

Drift to off-target areas is always a concern during the application of roadside herbicides. In an effort to minimize drift potential, ODOT addressed this issue in their “Herbicide Program Policy” (Section 4.6). In Part III, under “Application Specifics,” guidelines and procedures are listed for ODOT applicators to follow during the herbicide application process. Since ODOT has adopted the policy of using drift control products with all broadcast applications it is important that ODOT personnel have access to quality drift control products that will mix well with the herbicides they intend to use.

## **6.2 COMPATIBILITY OF ADJUVANTS AND HERBICIDES**

The best way to determine if adjuvants such as surfactants and drift control products are compatible with herbicides is to test them using an industry standard “Jar Test”. Under the current ODOT AHAL program all surfactants and drift control products must be tested and proven compatible before manufacturers or distributors can submit bids on that specific product. When implemented, this procedure will keep problematic surfactants and drift control products out of the hands of ODOT personnel. Both liquid and dry forms of drift control products that are currently listed on the AHAL (Chapter 14) have been shown through testing by Oklahoma State University to be compatible with most if not all herbicides commonly used by ODOT.

## 6.3 DRIFT CONTROL PRODUCTS

Correctly used drift control products do just what their name implies, help ODOT control drift. Drift control products can be purchased in both liquid and dry form. The dry form is usually a drift control product which has been coated onto a sprayable grade AMS. Before ODOT personnel choose to use a dry drift control product they must remember the AMS carrier can increase the activity of their chosen herbicide. This may or may not be a good thing dependent on their situation. When appropriately used a drift control product works by preventing the spray solution from atomizing into the typical wide range of droplet sizes. When the herbicide and water mixture leaves the spray tip under pressure it will produce a designated pattern that will have a wide range of droplet sizes. These variable sizes are necessary for the performance of the spray application but if too many fine spray particles are produced, excessive drift may occur. The drift control products help reduce the number of fine particles produced at the tip by changing the characteristics of the spray solution, essentially preventing the formation of smaller droplets that tend to drift off target. Drift control products are sometimes difficult to handle and hard to get mixed with an herbicide and water mixture. The most important thing is to use up the liquid drift control products each year and try not to carry any over to the following year. The liquid drift control products do have a shelf-life which means they have a tendency of separating out and can be difficult to shake up over time. Never add a liquid drift control product to a tank load of mixed herbicide if it has separated to the point where it cannot be reshaken effectively. In the past there have been liquid drift control products that for whatever reason were not compatible with herbicides. Even when these products were brand new they would not mix with certain

herbicides effectively. All of the liquid and dry drift control products listed on the AHAL must have been tested and approved before ODOT will accept bids on a particular product. This should eliminate problems with future incompatibility from listed drift control products.

## **6.4 SURFACTANTS**

Surfactants are considered surface active agents or wetting agents. They perform by increasing the contact area between the liquid (herbicide/surfactant mixture) and the leaf surface of the targeted weed. This is usually accomplished by reducing the surface tension of the spray droplet. This in turn enhances the activity of the herbicide treatment. For example, when a water droplet is applied to a waxy leaf, the droplet forms a round bead due to water surface tension. However, when a surfactant is added to the water, the droplets will spread out more readily, as the surface tension of the water droplet has been reduced.

Previously, many people believed that products such as soaps or household detergents could be used as herbicide compatible surfactants. This was due to the fact that these products also lowered the surface tension of water. However, their use often leads to undesirable consequences for several reasons. First, soaps and detergents can combine with hard water to form precipitates or scums. These can interfere with the performance of the herbicides and sprayer equipment. Formulated agricultural surfactants do not form precipitates and can be used equally well in either hard or soft water. Secondly, many liquid detergents and soaps create too much foam for use in a sprayer tank. Finally, most liquid detergents have a fairly low concentration of

surfactant (10 to 20 percent) compared with a 50 to 90 percent concentration for most agricultural surfactants.

The nonionic surfactants (NIS) are the most common type of surfactants used in spray applications. These NIS do not have an electrical charge when mixed with water. They are generally considered good dispersing agents, stable in cold water and are low in toxicity to both plants and mammals. A nonionic surfactant is typically used at 1 to 2 quarts per 100 gallons of water which is the same as a 0.25 to 0.5 % by volume, solution, respectively. An NIS will generally be recommended in most instances when using foliar-applied herbicides such as triclopyr ester, Transline, metsulfuron methyl, glyphosate (aquatic), imazapyr, sulfometuron, Krenite and Vanquish to enhance the performance of the herbicide and improve weed control along Oklahoma roadsides. Non-ionic surfactants can be approved for use in terrestrial (land), aquatic (water) or both use sites. Never use a non-ionic surfactant that is only approved for terrestrial use on an aquatic site.

## **6.5 CROP OILS**

Crop oils, crop oil concentrates, and methylated seed oils are considered adjuvants which are similar to surfactants. They also improve the spreading of herbicide spray droplets on the leaves by reducing surface tension. Additionally, they improve the penetration of the herbicide spray droplet through the waxy layer (cuticle) on the targeted weed leaf surface. Crop oils will keep the leaf surface moist longer than water alone. Using crop oils results in allowing more time for the herbicide to penetrate, thus increasing the overall amount of herbicide which enters the targeted weed. Certain

families of herbicides that respond well to non-ionic surfactants may actually respond better to the use of crop oil. Herbicides such as Plateau, imazapyr, and Krenite are examples.

Today, most crop oil concentrates will contain 80 to 83 percent oil and 17 to 20 percent surfactants. Crop oils are typically used at higher rates than nonionic surfactants. Commonly used rates of crop oils are 2 to 5 quarts of crop oil per 100 gallons of water (0.5 to 1.25 % solution). At the higher rates the crop oil itself will tend to slightly burn the edges of weeds and brush.

## **6.6 AMMONIUM SULFATE**

Ammonium sulfate (AMS) can be classified as a spray tank adjuvant. When added to specific herbicides, it will enhance their performance. Previous research conducted at Oklahoma State University has indicated that the addition of AMS to treatments of Campaign or glyphosate can improve the control of winter annual grasses and broadleaf weeds in dormant bermudagrass roadsides. The mode of action of AMS is believed to be that of a buffering agent (lowers water pH). Its use allows less of products such as Campaign or glyphosate to be potentially “tied up” in hard water, or those waters having a higher pH. This allows more of the herbicide to be available for uptake by susceptible, targeted weeds, thereby increasing the potential activity and performance of the treatment. AMS does not exhibit herbicidal properties when used alone. AMS, when combined with specific herbicides, may allow for a quicker kill of undesirable vegetation. The use of AMS at a rate of 17 pounds (7.7 kg) of product per 100 gallons (379 liters) of water carrier, combined with Campaign herbicide, has made it



possible to lower the labeled use rate of Campaign from 4 pints to 2 pints per acre while achieving the same level of weed control (Section 5.3). This action has allowed not only a more economical herbicide treatment while maintaining weed control, but also results in less herbicide being used on the roadside environment. Herbicide treatments using glyphosate alone could also benefit from the addition of AMS.

# **CHAPTER 7.0 BIOLOGICAL WEED CONTROL**

## **7.01 PURPOSE**

The purpose of this chapter is to discuss the use of biological control methods to manage musk thistles.

## **7.05 INTRODUCTION**

Biological control of weeds involves the use of natural enemies of weedy plants to reduce their population in an area. Examples of biological control agents include insects, bacteria, fungi, viruses and even animals. Biological controls are merely one type of tool that ODOT personnel can use in an integrated roadside vegetation management program. Currently, the only biological control agent that appears practical for ODOT personnel to utilize in their weed control programs is the musk thistle head weevil.

## **7.1 MUSK THISTLE HEAD WEEVIL AND THE MUSK THISTLE**

The thistle head weevil (*Rhinocyllus conicus*), commonly referred to as the musk thistle head weevil in Oklahoma, is a natural enemy of musk thistles. In order to use this biological control agent to ODOT's advantage, one needs to understand the nature of the weed problem, behavior of the musk thistle plant, additional management tools for integrated thistle control, and musk thistle head weevil behavior.

## **7.2 MUSK THISTLE AS A WEED PROBLEM**

Musk thistle (*Carduus nutans*) is a non-native, invasive thistle, and a serious weed problem in many areas of Oklahoma. Under good growing conditions, musk thistle plants can reach heights of 6 feet (1.8 m) or more. The tall, upright growth habit of musk thistle can reduce site distance in the clear zone of the right-of-way. Additionally, musk thistle is a serious weed of range and pasture areas adjacent to the rights-of-way. Livestock will not graze infested areas. Moderate infestations can reduce pasture yields by up to 20 percent and severely reduce hay quality. Musk thistle is a legally declared noxious weed in all 77 Oklahoma counties along with Canada thistle and scotch thistle (refer to Chapter 12.2.1)

## **7.3 MUSK THISTLE LIFE CYCLE**

Musk thistle is usually a biennial, meaning that it requires two growing seasons to mature and produce seed. Occasionally, musk thistle requires only one year to complete its life cycle. During the growing season, seedlings may emerge anytime when moisture conditions are favorable. During the first season, plants normally are low growing, staying in the rosette (vegetative) stage of growth. In the spring of the second year, plants usually start bolting (growing upright) by mid-April, producing flower heads from May through June, and then die after seed is produced. Musk thistle reproduces only by seed. Each plant is capable of producing more than 10,000 seeds. Some of this seed will germinate the same year that it is shed, while a portion can remain viable in the soil for up to five years.

## **7.4 INTEGRATED MUSK THISTLE CONTROL STRATEGIES**

Several methods are available for use in control of musk thistle. These include mechanical removal (mowing, shovel, tillage, machete, etc.), chemical (herbicides, salt), and biological (musk thistle head weevil). An integrated approach using the best combination of these individual tools is suggested for use by ODOT.

### **7.4.1 Mechanical Control**

Mechanical control involves the use of tilling, mowing or cutting.

#### **7.4.1.1 Tillage**

Tillage for musk thistle control can be used in rare cases where the soil does not contain any desirable vegetation and/or where establishment of desirable vegetation is being planned in the near future. Tillage usually destroys existing plants through mechanical damage to the plant and subsequent desiccation or drying out.

#### **7.4.1.2 Mowing**

Mowing can be used in some instances to manage or control musk thistle. Mowing as an exclusive management tool is usually not completely successful. It is most useful in reducing plant height and improving sight distance, and/or removing existing flowers and allowing more time during which an herbicide application can be made.

Mowing of thistle in the rosette or vegetative stage often has little to no effect on its growth or development. Use of mowing as a management tool during the flowering

stage of the life cycle improves site distance, however, it usually merely reduces the amount of seed set or delays the plant from setting seed until new growing or flower points are formed. If seed in the flowers has adequate time to mature, mowing flowering thistles may not keep the seed from becoming viable (even when cut from the plant) and capable of continuing the weed problem in the future. Occasionally, mowing late in the flowering cycle during a time period when inadequate soil moisture is present for regrowth will lead to the death of the remainder of the musk thistle plant.

Several problems exist with the exclusive use of mowing in an attempt to kill the musk thistle plant. These include: 1) in order to kill the plant and keep it from setting seed, it must be mowed below the lowest set of leaves or else dormant buds at the base of these leaves will begin growth and continue to produce flower heads; 2) mowing below the lowest set of leaves and low enough to kill the musk thistle plant usually means that severe scalping of the desirable vegetation will occur, leading to exposure of bare soil and increased risk of soil erosion; and 3) mowing low enough to kill the thistle plant may involve departure from the general mowing policy statement (Section 2.3.4) stating that “The mowing height will not be less than 6 inches (in height)”. Also be aware that because of the hollow stems of musk thistle, the stems tend to bend over before mowing. This makes achieving a clean cut very difficult. While they may be bent over and chewed up, adequate soil moisture in spring may still allow them to flower.

#### **7.4.1.3 Cutting**

Hand cutting of the thistle plants at slightly below the soil level, using a machete, shovel or other tool is an excellent way of killing musk thistle plants in both the rosette

and flowering stage when only a few plants are present in an area. It is critical that they be cut just below the soil level to ensure that resprouting does not occur.

#### **7.4.2 Chemical Control**

Chemical control of musk thistle can be very effective when properly timed. It is best applied in the rosette stage in the fall and early spring before plants bolt. Chemical control strategies can involve the use of an herbicide or the use of salt.

##### **7.4.2.1 Herbicide Use for Musk Thistle Control**

Herbicide control strategies for Musk Thistle are discussed in detail in Section 5.

##### **7.4.2.2 Salt for Musk Thistle Control**

The salt or fertilizer ammonium nitrate (analysis 33-0-0 or 34-0-0) has been effective for controlling small musk thistle plants (< 8 inches [20.3 cm] across). The salt desiccates the young plant. Ammonium nitrate then becomes available for the surrounding vegetation to use as a nutrient source. Oklahoma State University does not suggest the use of this method for musk thistle control. The method involved placing up to one teaspoon of ammonium nitrate in the center of each rosette. This method was most useful when only a small number of plants were present. In practice, use of a hand tool to physically kill or remove the plant will be more expedient and practical.

### **7.4.3 Musk Thistle Head Weevil**

Satisfactory to good control of musk thistles using the head weevil has been reported in several states. Missouri has demonstrated a 50 to 95 percent reduction in thistle populations with release of the weevil. Advantages of the use of the musk thistle head weevil also include: 1) low cost, 2) ease of establishment, 3) requires little effort once established, 4) very few other non-target plants are affected by the weevil, 5) adjoining infestations of musk thistle on range and pasture land will attract weevils, 6) compatible with other integrated control practices, and 7) beneficial in ODOT's public relations efforts.

#### **7.4.3.1 Life Cycle of the Weevil**

Understanding of the life cycle of the weevil aids in success in collection, transport and establishment of the weevil into a musk thistle control program. The musk thistle head weevil overwinters as an adult. In early spring, they feed on seed heads. The eggs are laid on the bracts (green undersides) of developing flowers. Each female lays approximately 100 eggs. The eggs hatch in 6 to 8 days and the larvae bore into the bottom of the bract and begin feeding on flower heads for 25 to 30 days. It is this feeding activity and further invasion of the wounds by bacteria and fungi that leads to the destruction of the musk thistle seed. Larvae next stop feeding and enter a resting stage (pupae) that lasts another 8 to 14 days. In June, adults emerge to seek overwintering sites. A second generation can occur in some locations under mild, moist summer conditions.

#### **7.4.3.2 Collecting and Releasing Weevils**

A good time to collect weevils is after plants have bolted 1 to 2 feet (about mid-May). Collect on sunny days when weevils are active on the upper portions of the plant. Weevils are collected by beating the upper portions of the flowering musk thistle plant with a dowel rod while holding a sweep-net or some other device beneath the plant. Leather gloves are required for holding plants. Weevils play dead and drop into the sweep-net. A small amount of musk thistle foliage may be placed into the bottom of the sweep nets to provide security for the weevil and to minimize their escape attempts. Move from one plant to another, repeating this process. Occasionally tap on the net to keep weevils from escaping.

After collecting weevils, sort through the debris and separate weevils from other insects and spiders. Place approximately 500 adult weevils in cardboard containers with tight fitting lids. The lids should be secured with a couple of wraps of masking tape to prevent them from accidentally coming loose. Poke several small diameter holes in the lid of the container to allow air to move into them. The holes should be small enough that weevils cannot crawl through the holes and escape. Do not use plastic cartons since moisture accumulation will result in weevil death. Store the cartons in a refrigerator or ice chest. If using an ice chest, place the cartons such that water from melting ice will not enter the storage cartons.

Weevils can be stored for a week in a refrigerator or ice chest. However, they should be released prior to this (as soon as possible) to ensure that eggs are not deposited in storage containers.



Locate a site where flowering musk thistle plants exist and where few to no weevils can be found. At least 500 weevils should be released at each site. Simply sprinkle weevils over the plants at a rate of about ten per plant.

Check the site in approximately 3 weeks or more to look for small holes bored in the undersides of the seed heads. Sample a few seed heads by cutting them open with a pocket knife and confirming the presence of the feeding larvae or injury to the seed that they have caused.

Studies have shown that releases are most successful if the area is not mowed, sprayed or disturbed during critical times in the life cycle of the weevil, such as flower head development. Remember, it can take a few years for weevil populations to reach a point where substantial thistle control occurs.

#### **7.4.3.3 Integrated Musk Thistle Control**

Once an area has a heavy infestation of musk thistles, the most economical approach is an integration of various control options. A good integrated management approach would include:

1. Release of thistle head weevils (500 per site) on thick stands of musk thistle. There is a better chance of weevil survival if the area is undisturbed for a couple of months after release. It is also important to protect these areas for several years to insure maximum opportunity of a successful weevil population. After several years, herbicide spraying and mowing can be integrated into these areas.

2. Encourage landowners of infested pastures and adjacent areas to stop musk thistle seed production. Seed production can be stopped by selective mowing and spot treatment with herbicides.

3. Integrated control methods. Researchers in Missouri found that the best approach was to spray rosettes in the fall and from mid-March to mid-April; letting the head weevils disrupt seed development in May and June, then mow off unsightly plants.

#### **7.4.3.4 Weevil Release Record Keeping**

ODOT personnel should keep a record of the date, location, and estimated number of weevils collected and released along right-of-ways. This information should be supplied as a part of the annual herbicide reporting process. This information is useful in documenting the continued use of truly integrated vegetation management programs by ODOT and their efforts to comply with the Oklahoma Noxious Weed Law.

# **CHAPTER 8.0 HERBICIDE PRECAUTIONS**

## **8.01 PURPOSE**

The purpose of this chapter is to help the applicator use pesticides in a responsible manner through the development of an understanding of how pesticide exposure occurs, pesticide toxicity, use of personal protective equipment as well as appropriate pesticide mixing, loading and application techniques.

## **8.05 INTRODUCTION**

There are risks associated with the use of any herbicide. These risks could be to the safety of the applicator or the environment. It is important for all ODOT herbicide applicators to know and respect the risks associated with the use of herbicides. Applicators should realize that by following all label directions and information gathered in training programs they are minimizing any potential negative effects to themselves or the environment. Today's EPA pesticide registration process includes major advantages for chemical companies that produce pesticides which have high degrees of both environmental and applicator safety. This means a cost savings to the chemical companies but more importantly, it means "reduced risk" or more "environmentally friendly" pesticides will remain registered for use by ODOT applicators.

## **8.1 APPLICATOR SAFETY**

Every herbicide used by ODOT has a certain amount of toxicity of which applicators should be aware. Herbicide toxicity varies greatly among different

herbicides and is dependent on the herbicide's active ingredient, formulation, and inert ingredients. As an applicator, one cannot change the toxicity of a particular herbicide formulation. One can, however, reduce risks by minimizing exposure to the herbicide. Without an exposure, even the most toxic of herbicides will not adversely affect the applicator. The safety risk to the applicator is greatest during the mixing and loading process because this is when the pesticide is in its most concentrated form.

$\text{Reduce Risk} = \text{Minimize Exposure} \times \text{Toxicity}$
--

Herbicides can enter the body in three ways:

Oral - through the mouth

Dermal - through the skin

Inhalation - through the lungs

Ocular – through the eyes

One of the most important factors that influences the major route of entry for a particular herbicide is the pesticide formulation. In general, most dry formulations do not readily absorb through the skin. Dry formulations such as wettable powders, soluble powders, dry flowables, and water dispersible granules will however offer a much higher risk of inhalation to the applicator because of the dust created during mixing. Liquid formulations such as emulsifiable concentrates will readily absorb through the skin and eyes but have only minor inhalation problems. The most common route of entry for all herbicides is dermal absorption through the hands, wrist area and forearms. Oral, dermal, inhalation and ocular exposure to herbicides can be caused by:

Oral - not washing hands before eating, smoking, or chewing; or careless mixing techniques.

Dermal - not washing hands after handling herbicides, splashing or spraying on unprotected skin, wearing contaminated clothing, applying herbicides in windy weather, or inadequate protective clothing.

Inhalation - careless mixing techniques or inadequate protective clothing.

Ocular - splashing or spraying pesticides in eyes, applying sprays or powders in windy weather, rubbing eyes with contaminated hands or gloves, transferring dust, granules or powder formulations without eye protection.

### **8.1.1 Acute Exposure and Toxicity**

Acute exposure is a single exposure to a large amount of herbicide. Usually the symptoms of poisoning begin quickly (within a few minutes to a few hours) and leave little doubt about the cause of the illness. Serious acute exposure is usually due to an accident involved in the mixing, loading, or transport of the herbicide concentrate. Once an herbicide is diluted in a tank mix with water, serious poisoning due to acute exposures to herbicides used by ODOT are not likely to occur. There is, however, always the chance that someone may be allergic to a particular herbicide. Once diluted, if a small exposure does irritate the skin, it is likely an allergic reaction and the employee should not handle, mix, or use that particular herbicide.

All herbicides have a certain amount of acute toxicity. In other words, how much of a particular herbicide does it take to be acutely toxic (one dose) to an applicator? The term LD<sub>50</sub> is used to express the level of acute toxicity of herbicides. Having LD<sub>50</sub>

values for herbicides allows an applicator to compare one with another to see which product may be safer to handle and use (Table 8.1). LD means lethal dose. LD<sub>50</sub> is the amount of the herbicide in milligrams (mg) it takes per unit of body weight in kilograms (kg) to be lethal to 50 percent of a population of test animals. The lower the LD<sub>50</sub> value, the more acutely toxic the herbicide. An herbicide with an oral LD<sub>50</sub> value of 500 would be 10 times more acutely toxic than one with an oral LD<sub>50</sub> value of 5,000. In Table 8.2 one can determine the probable dose it would take from a particular herbicide to be lethal for a 150 pound man based on the LD<sub>50</sub> value of the herbicide. A woman or a man smaller than 150 pounds would require slightly less of a dose than indicated by the chart. A man larger than 150 pounds would take a higher dose to be lethal.

It is not practical for an herbicide handler to have to stop and calculate the amount of herbicide it would take to cause a serious health threat. If desired, a person could however calculate using the acute LD<sub>50</sub> value and exact body weight to amount of herbicide it would take to create a serious hazard. A much more practical approach to determining the hazards of a particular herbicide is by using the signal word (danger, warning, or caution) on the herbicide label. Every label contains a signal word indicating how dangerous the product is to humans (Table 8.3). Knowing the product's hazard helps the applicator choose the proper precautionary measures for themselves, other workers, and other persons (or animals) which may be exposed. The signal word must appear in large letters on the front panel of the pesticide label. It immediately follows the statement, "Keep Out of Reach of Children," which must appear on every pesticide label.

DANGER—This word means that the pesticide is highly toxic. A taste to a teaspoonful taken by mouth could kill an average sized adult. Any product which is highly toxic orally, dermally, or through inhalation or causes severe irreversible eye and skin burning will be labeled “DANGER.” All pesticides which are highly toxic orally, dermally, or through inhalation will also carry the word POISON printed in red and the skull and crossbones symbol.

WARNING—This word means that the product is moderately toxic. As little as a teaspoonful to a tablespoonful by mouth could kill the average sized adult. Any product which is moderately toxic orally, dermally, or through inhalation or causes moderate eye and skin irritation will be labeled WARNING.

CAUTION—This word means that the product is slightly toxic. An ounce to more than a pint taken by mouth could kill the average adult. Any product which is slightly toxic orally, dermally, or through inhalation or causes slight reversible eye and skin irritation will be labeled CAUTION.

### **8.1.2 Chronic Exposure and Toxicity**

Chronic exposure is a repeated exposure to small amounts of herbicides over a relatively long period of time. Chronic exposure usually occurs when daily use of an herbicide results in small daily exposures for several weeks, months or years. While these small exposures by themselves would not create any noticeable illness, some herbicides can remain in the body long enough for multiple exposures to accumulate. If accumulation continues, some herbicides may produce chronic toxicity. Most of the herbicides used currently by ODOT have not resulted in any problems with chronic

toxicity. While this does not mean small daily exposures should be ignored, it does mean that ODOT applicators should not feel undue concern about the long term health effects posed to them by the herbicides in their programs. There is no "LD<sub>50</sub>-type" value to measure chronic toxicity. Chronic toxicity is determined through long-term laboratory studies which evaluate adverse health effects from a specific herbicide. Chronic adverse effects may include:

Carcinogenesis (oncogenesis) - production of tumors that may or may not be malignant.

Teratogenesis - production of birth defects.

Mutagenesis - produces changes in genetic structure.

Reproductive Toxicity - produces negative effects on reproductive systems.

Adverse health effects resulting from chronic toxicity are more subtle than those from acute toxicity and, therefore, their detection and diagnosis can be more difficult. The best way to prevent chronic toxicity is to carefully select safer herbicides and to use appropriate personal protective equipment (PPE) which minimizes applicator exposure to herbicides.

### **8.1.3 Personal Protective Equipment (PPE)**

The herbicide applicator is ultimately responsible for using all the appropriate PPE suggested on the herbicide label(s). While it is the responsibility of the department to make PPE available, it is up to the county foreman and applicators to secure, use, and maintain PPE. PPE used for herbicide safety should never be used for other types



of maintenance duties. The use of PPE is most critical during the mixing, loading, and transport of the herbicide concentrate. However, once diluted in a tank mix, PPE should also be used if the spray equipment must be maintained in any way.

As an applicator one is required under the Federal Insecticide, Fungicide and Rodenticide Act (FIFRA) to follow all label directions, which includes PPE statements. Most labels have basic statements as to minimum PPE, however, some labels only require the use of "appropriate protective clothing and equipment." In cases such as these, one must consider the herbicide formulation and use common sense to select appropriate PPE. Refer to Table 8.4 for recommended PPE when using herbicides commonly applied by ODOT.

The minimum level of body covering protection for all pesticide applicators is a long-sleeved shirt, long trousers and shoes and socks. The purpose of PPE is to prevent skin contact with pesticides and thus reduce or eliminate



with

dermal absorption.

Another very useful item is a plastic apron during the mixing process prevents pesticide and makes laundering much



apron. Wearing an apron exposure to the concentrated easier and more effective.

When handling any herbicide (diluted or not) you should wear gloves. The minimum requirement is that the glove should be liquid proof and cover the wrist area. However, with some of the herbicides utilized by ODOT, liquid proof does not give adequate protection from the solvents, etc. in certain formulations. In cases such as these, nitrile gloves are needed for chemical protection and should be at least 15 mm thick. All protective gloves should

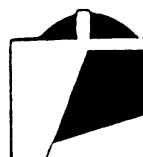
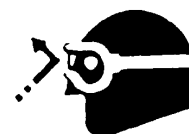


be unlined. Reusable gloves should be cleaned with soapy warm water on a daily basis and checked for leaks.

A hat should be worn to prevent any spray from contacting the head, eye, and neck area. Remember, if baseball style caps are used, they should be washed periodically to remove residues. With respect to footwear, remember that any shoe or boot contaminated with an herbicide concentrate cannot be cleaned effectively. If contaminated footwear is worn, there will likely be a daily chronic exposure for a long period of time. This may or may not lead to a chronic toxicity problem, but it should be prevented. Footwear that is contaminated with diluted herbicide may be cleaned and is not a serious problem. During mixing and loading procedures, it is important to wear some type of waterproof boot or overshoe.



One of the most common problems from herbicide exposure comes from accidental contact with the eyes. While most herbicides cause only temporary and reversible eye irritation (exception-Garlon 3A), the burning and redness can be very uncomfortable. Personnel who do not wear eyeglasses may prevent eye exposure by wearing protective splash goggles. Regular eyeglasses and most shop safety glasses do not provide adequate protection from splashes. Eyeglass wearers usually must use a face shield primarily because of the discomfort from or rubbing your eyes when handling herbicides. This act can result in a small but uncomfortable exposure.



Respirators are typically only worn when required by the herbicide label or when handling wettable powder formulations. To be effective, a respirator must produce a tight facial seal. Personnel with beards or mustaches should not handle any herbicide that requires use of a respirator. Respirator cartridges should be replaced before each spray season and prefilters (if present) should be replaced weekly. Most respirator cartridges for pesticides contain carbon in their filters. To maintain the effectiveness of a filter, the entire respirator/filter should be stored in a tightly sealed plastic bag when not in use. Only use those respirators/filters which have been approved for pesticide use by National Institute for Occupational Safety and Health (NIOSH).



#### **8.1.4 Laundering Clothing and Cleaning PPE**

It is nearly inevitable that anyone mixing or spraying an herbicide will get a small amount of either the concentrate or diluted product on one's clothing or PPE. Handling herbicides as carefully as possible will minimize the exposures but an applicator should always treat work clothes and PPE as though they have some residue on them. The following procedures should be followed in the laundering of contaminated clothing:

1. Any clothing heavily contaminated by a large amount of herbicide concentrate should be discarded.
2. All clothing receiving daily exposures should be laundered daily.
3. Pre-soaking, pre-rinsing or spraying/hosing garment(s) outdoors is recommended prior to laundering.
4. All clothing should be laundered separately from family clothing.

5. Use maximum recommendations for detergents.
6. Liquid detergents have proven to be more effective at removing emusifiable concentrate residues.
7. Use machine settings for hottest (140°F/60°C) water, full water, and normal (12 minute) wash cycle.
8. Clothing contaminated with small amounts of herbicide concentrate requires a minimum of 2 washings.
9. Clothing contaminated with diluted herbicides may be effectively cleaned in a single wash.
10. If possible, line dry outside. Sunlight will aid in the breakdown of any residue and prevent contamination of your dryer.
11. All herbicides, concentrated and diluted, will leave a small amount of residue inside the washer. To aid in cleaning, run a normal cycle including detergent without clothes in the washer.

PPE should be thoroughly cleaned on a daily basis using a soap/detergent and warm water. Reusable gloves, boots, aprons, goggles and any other PPE should be wiped off or brushed with the cleaning solution to remove residues. This action prevents a build up of residue and extends the life of the PPE. After washing, PPE should be allowed to dry before being stored. It is acceptable to use ammonia or bleach to help decontaminate both clothing and PPE. You should never use both bleach and ammonia at the same time as toxic fumes can be formed.

### **8.1.5 Handling, Mixing and Application Precautions**

One should always handle an herbicide cautiously whether it is the safest or most hazardous product on the market. Wearing PPE and paying attention to details will reduce possible exposure. The following are some other suggestions for mixing procedures, handling and application techniques that may help reduce exposure to herbicides:

1. Always keep the wind at your back when mixing.
2. Always hold container or bag below shoulder level when mixing.
3. If possible, hold containers inside mouth of tank and pour (especially with dry formulations like sulfometuron that will create some herbicide dust).
4. Always add drift control products to the tank last.
5. Once a tank load of herbicide is mixed, never shut agitation off.
6. Drift control products should be added slowly through the top of spray tank or by using an injection system.
7. Always use an anti-siphoning device on the water source or maintain an air-gap to prevent back-siphoning. Never leave a water hose down inside a tank unattended.
8. Do not fill, mix/load or clean sprayers near any well. It is best to stay 50 feet downhill from a well.
9. Keep spray equipment well maintained to prevent leaks, breaks, etc.
10. Never spray directly into the wind if possible.
11. Store herbicides separately from other materials.

12. Properly triple-rinse or power-rinse herbicide containers as they are emptied prior to disposal or recycling. New EPA regulations require the rinsing process to be done immediately upon emptying each container.
13. Never repackage an herbicide no matter how small an amount remains in the original container.
14. Never use more than the optimum spray system pressures (25 psi for boom buster nozzles or 30 psi for solid-stream nozzles).
15. Spray equipment should be cleaned periodically as per guidelines in Chapter 10, Section 10.8.
16. Always open containers at the point of mixing, do not open containers on the ground and hand them up to someone at the mouth of the tank.
17. It is a good idea to carry a shovel and bag of absorbent material on the spray truck to handle small spills.
18. Always carry clean water and soap on the spray truck to wash hands, etc. before taking breaks or lunch.
19. All PPE should be cleaned daily and allowed to dry before reuse.
20. Never use herbicide PPE for any other use unless it has been specified by your supervisor to do so.
21. Always read and follow all label directions and have labels on the spray truck during all applications.

## **8.2 MINOR HERBICIDE SPILL CLEANUP**

By Oklahoma state law a minor herbicide spill is defined as a spill of less than 25 pounds (11.4 kg) of herbicide concentrate, 10 gallons (37.9 liters) of herbicide concentrate or 50 gallons (189 liters) of an application mixture. A minor spill does not require any notification of the Oklahoma Department of Agriculture, Food, and Forestry (ODAFF) or the Oklahoma State Department of Health (OSDH), but it does require proper procedures to effectively clean up the spill and surrounding area. How a spill is cleaned up depends on what herbicide was spilled, formulations and the type of surface the herbicide was spilled upon. Regardless of the surface type, do not immediately rinse the spill with water. If the spill was an herbicide concentrate on a hard surface, it is best to use some type of absorbent material (floor sweep, kitty litter, soil, sawdust, etc.) to first absorb, then remove as much product as possible. The absorbent material/herbicide may then be distributed evenly over a large area of roadside right-of-way or over the gravel/dirt portion of an ODOT facility yard that would be an appropriate use site as per label directions. After this step, the spill area should be treated with either ammonia or bleach and sprayed with water to remove any final product. Only spray enough water to clean the spill area while trying to keep the water inside the ODOT facility yard. A spill of an herbicide concentrate on a soft surface should be dug up and contained entirely in buckets or barrels. Do not spray any water on an herbicide spill to areas of soil or gravel. After the entire spill and surrounding soil/gravel has been removed these materials may be disposed of by distributing evenly over a large area of roadside right-of-way or an appropriate target use site. Cleanup of a minor spill from a diluted application mixture is much simpler than a spill of the herbicide concentrate.

Under most circumstances, a minor spill of a diluted application mixture does not require any clean up unless it is on a hard surface. On a hard surface allow the liquid to evaporate then decontaminate the surface using bleach or ammonia, followed by a brief hosing off. For major spill cleanup procedures refer to Section 12.2.6.

### **8.3 ENVIRONMENTAL SAFETY**

It is the responsibility of all ODOT personnel to make sure that ODOT herbicide use has as small an impact on the roadside environment as possible. If used according to label directions and ODOT guidelines, all possible adverse effects will be minimized. ODOT currently uses some of the most environmentally sound herbicides ever produced to manage roadside vegetation. However, the single most important factor in minimizing the effect of pesticide use on the environment is still the applicator. The applicator should make the judgment on when, where, and under what conditions an application is made. His/her decisions are crucial in making sure that the herbicide is applied only to the rights-of-way and that sensitive areas and drift are managed properly.

#### **8.3.1 Sensitive Areas**

A sensitive area is an area on or immediately adjacent to a roadside right-of-way that has special environmental concerns. The main sensitive areas shared by all counties would include but are not limited to: all areas with surface water, nearby crops, nearby gardens, frozen soils, houses or businesses with frontages maintained as a lawn, designated scenic byways, desirable native species, wildlife habitat areas, and



any roadside right-of-way less than 15 feet wide. Refer to Table 8.5 for special precautions around sensitive areas.

### **8.3.2 No Spray Buffer Zones**

While it is not an ODOT policy, it is a good practice to leave untreated buffer zones along all state highways treated with herbicides. A buffer zone is an untreated area of the roadside right-of-way between the treated area and the right-of-way fence. The buffer zone serves several important functions. ODOT's basic core herbicide program consists of two broadcast applications. During winter annual weed control (February-early April) and summer weed control (late April-June) applications, it is important to use the buffer zones to trap any particle drift that may occur during the broadcast application. A buffer zone of at least 10 feet (3 m) will collect most drift before it reaches adjacent private lands. Any drift that falls outside the right-of-way fence is considered to be an off-target application and is a direct violation of state laws. A second important use of buffer zones is that they allow both ODOT and private landowners to see exactly where ODOT's herbicide application patterns begin and end. This helps assure them that the herbicides are kept on the intended targets. There is a tendency for ODOT crews to treat as wide a swath as possible to control johnsongrass and other weeds. The closer one gets to the right-of-way fence, the greater the potential for off-target drift. If a buffer zone area is to be targeted for treatment, it will likely be necessary to look into different application equipment or techniques. Equipment such as the boom-sprayers or wick applicators could be safely used in these areas. There is not a set distance for an affective buffer zone. The size of the buffer

zone could be as small as 10 to 20 feet around adjacent pasture and wooded lands, 100 – 300 feet near sensitive crops such as soybeans or milo, or even as large as 1/4 - 1/2 mile when ultra sensitive crops such as grapes or canola are adjacent to the highway. ODOT historically has done a very good job of managing buffer zones around traditional ag crops and home/garden areas but some of the new ultra-sensitive alternative ag crops require much larger buffer zones. Adjacent landowners growing ultra-sensitive crops (covered in annual training) next to the highway should be called on in person and an agreement as to an appropriate buffer zone size should be made and adhered to as closely as possible.

**Table 8.1.** LD<sub>50</sub> values for commonly used ODOT herbicides and drift control products (Trade names used).

Herbicide		Acute Oral LD <sub>50</sub>	Acute Dermal LD <sub>50</sub>
Roundup	Pro	5000	3536
Concentrate			
Oust XP		>5000	>8000
MSMA		1700	2500
Overdrive		1800	>5000
Plateau		>5000	>2000
Campaign		3860	>6366
Vanquish		3512	>2000
Garlon 4 Ultra		1600	>2000
Garlon 3A		3000	>5000
Krenite S		24400	>1680
Transline		>5000	>5000
Aquamaster		>5000	>5000
Outrider		>5000	>5000
Diuron 80 WDG		2900	2000
Banvel		2900	>2000
Tordon K		>5000	>5000
Arsenal		>5000	>2148
Escort XP		>5000	>2000
Telar XP		3053	3400
Hyvar X		2000	>5000
2,4-D		1161	1544
Milestone VM		>5000	>5000
Aspirin (for comparison)		1240	---
Table Salt (for comparison)		3320	---
Detain II (drift control)		>5000	

**Table 8.2.** Relative lethal acute dose of herbicide for 150 pound man.

Oral LD <sub>50</sub> Range	Dermal LD <sub>50</sub> Range	Probable Lethal Acute Dose for 150 Pound Man
0-50	0-200	<7 drops to 1 teaspoon
50-500	200-2,000	1 teaspoon to 1 ounce
500-5,000	2,000-20,000	1 ounce to 1 pint
5,000 +	20,000 +	1 pint to 1 quart

**Table 8.3.** Signal words from specific brand name herbicide labels.

Product	Signal Word
Aquamaster	Caution
Arsenal	Caution
Banvel	Warning
Campaign	Danger
Diuron 80 WDG	Caution
Escort XP	Caution
Garlon 3A	Danger
Garlon 4	Caution
Garlon 4 Ultra	Caution
Honcho Plus	Caution
Imazapyr 2SL	Caution
Krenite S	Caution
Milestone VM	Caution
Mirage Plus	Caution
MSMA 6-Plus	Caution
MSM E Pro	Caution
Oust XP	Caution
Outrider	Caution
Overdrive	Caution
Plateau	Caution
Ranger Pro	Caution
Roundup Pro Concentrate	Caution
Sahara	Caution
SFM E Pro	Caution
SFM 75	Caution
Telar	Caution
Tordon K	Caution
Transline	Caution
Vanquish	Caution

**Table 8.4.** Personal Protective Equipment.

Type	Herbicide Formulation	Minimum Level	Acceptable Materials
Body Covering	all formulations	long-sleeved shirt & long-legged pants coverall apron	woven, laminated fabric, denim, tyvek, pvc, woven plastic, nylon, pvc
Hat	all formulations	baseball style hard hat (unlined)	solid winter style pvc, vinyl (no cloth liners)
Gloves	all formulations	liquid proof or chemical resistant min.-15mm thick reusable (unlined)	latex, pvc, nitrile, neoprene (15 mm thickness)
Shoes and Boots	all formulations	sturdy canvas or leather (diluted only),  rubber or neoprene (concentrate)	canvas, nylon, leather  rubber, neoprene, pvc
Goggles or Face Shield	those required by labeling	chemical splash goggles  full face shield (eye glass wearers)	
Respirators and Cartridges	those required by labeling	Respirator, cartridge (approved for pesticides)	All respirators and cartridges should be approved for pesticide use by NIOSH.

**Table 8.5.** Sensitive areas and precautions on roadside rights-of-way.

Sensitive	Precaution
<p>All areas with surface water (ponds, streams, rivers, lakes)</p> <p>Standing water in ditches</p>	<p>All herbicides normally used by ODOT (except glyphosate (aquatic), Garlon 3A, or Habitat) are not labeled for aquatic use. Any herbicide found in these surface water areas could be reported as off-target or non use area applications. Many herbicides are toxic to aquatic organisms.</p>
<p>Nearby crops</p>	<p>Many landowners tend to plant agricultural (Ag) crops extending into roadside rights-of-way. Most herbicides used by ODOT are not labeled for use on Ag crops so illegal residues could be present if crops planted on roadsides are treated and grazed or harvested. Landowners should be approached concerning this problem, especially if erosion is present where crops are being planted.</p>
<p>Nearby gardens</p>	<p>Most flower or vegetable gardens are not use sites for ODOT herbicides. These plants are also very sensitive to herbicides. These factors along with the fact that citizens are usually very protective of their gardens, make these areas very sensitive. Roadsides should not be treated where gardens are immediately adjacent.</p>
<p>Frozen soils</p>	<p>Herbicides should never be applied to a frozen soil as there is a chance that rainfall following application could move a residual herbicide to off-target areas. Areas should be allowed to thaw before the application.</p>
<p>Houses or businesses with frontages maintained as lawns</p>	<p>Areas such as these likely qualify as turf areas and not roadsides if they are maintained as such out to the edge of the pavement. Unless contacted by the owner, these areas should not be treated.</p>

**Table 8.5.** Sensitive areas and precautions on roadside rights-of-way (continued).

Sensitive	Precaution
Designated scenic byways	Oklahoma is blessed with some very scenic byways. These areas deserve special consideration with respect to herbicides. If herbicides are to be used on these roadsides, it is important to have little if any noticeable visual impact. Minimize post-emergence treatments and rely on pre-emergence treatments if possible.
Narrow roadside rights-of-way (< 15 ft)	It is the recommendation that all broadcast applications should leave untreated buffer zones. If roadsides are narrow and spray equipment or technique does not allow for a buffer zone, then the area should not be treated. It may be possible to use a small boom buster tip, a handgun, boom sprayer or ropewick to apply an herbicide. Usually the area should be maintained with mowers.

# **CHAPTER 9.0 HERBICIDE APPLICATOR CERTIFICATION AND TRAINING**

## **9.01 PURPOSE**

The purpose of this chapter is to provide information concerning pesticide applicator certification, continuing education, recertification and the record of applicator training.

## **9.1 WHY PESTICIDE APPLICATOR CERTIFICATION?**

Pesticide applicator certification is required by the U.S. Environmental Protection Agency (EPA) for persons purchasing or using restricted-use-pesticides (RUP). The regulation is under the Federal Insecticide, Fungicide and Rodenticide Act (FIFRA) Part 171. Requirements listed in Part 171 are intended as a minimum and set a federal standard from which the states can work. Many states have incorporated stricter regulations than the federal regulations.

Pesticide Applicator Certification initially is the process by which a person completes state requirements to purchase and use pesticides. EPA only requires an individual to become a certified pesticide applicator if the individual is using a restricted-use-pesticide (RUP). Also, the Oklahoma Department of Agriculture, Food, & Forestry (ODAFF) requires any commercial applicator to be a certified pesticide applicator regardless of the pesticide classification. Oklahoma requires all other pesticide applicator classifications (this includes the ODOT non-commercial) to be certified if they purchase or use an RUP. ODOT currently uses only one restricted-use-pesticide (Tordon). Even though Tordon is used very little, it still lends credibility to the program



to certify applicators that will be using it as well as other herbicides. OSU's Pesticide Applicator Education program and the ODAFF strongly encourage any pesticide applicator to be certified in the appropriate category regardless of their classification.

The main intent of pesticide applicator certification in Oklahoma is to increase the awareness for (a) pesticide safety, (b) proper use, (c) understanding of the pesticide label and its importance, and (d) ensure environmental water quality. Although additional information is provided, the above are corner stones of the certification program.

## **9.2 ODOT HERBICIDE POLICY ON CERTIFICATION AND TRAINING**

As defined in ODOT Policy D-504-1 (Section 4.6) the Department has developed formalized certification and training guidelines for all herbicide applicators. By policy, all herbicides applied by ODOT will be applied by an applicator who has met the certification standards set forth by the ODAFF for Category 6 Rights-of-Way certification. This certification should ensure the citizens of Oklahoma that all herbicide applications made to state maintained roadsides are being made by a professionally certified applicator. To strengthen its commitment to training, ODOT policy also includes provisions that all employees involved with the application of herbicides are to attend yearly continuing education training.

### **9.2.1 Initial Pesticide Applicator Certification**

To become a certified applicator in the state of Oklahoma, personnel must meet the minimum certification standards set forth by the Board of Agriculture, ODAFF for a

given category. The primary category of certification for ODOT personnel is Category 6 (Rights-of-Way), however, Category 5 (Aquatic Weed Control) may also be required at ODOT facilities that find themselves spraying vegetation in aquatic areas such as wet ditches, bridge ends, etc. There are two ways to become certified initially in Oklahoma. The first is to successfully pass (minimum score of 70%) both the general and category exams. The second method is to become certified in the same category in a reciprocating state and petition for certification with the ODAFF. The certification obtained by ODOT personnel is not a license to spray pesticides, however, it does allow the applicator to work under the license secured annually by ODOT. For information on ODOT's pesticide applicator license, refer to Section 12.2.2. The certification obtained by ODOT personnel will be classified as a non-commercial certification. As a government employee, there is no charge for initial certification or any future recertification.

To prepare ODOT personnel for the exams, each year there are two-day schools performed at hosting field division headquarters in late fall or early winter. The number and location of the schools are dependent on the statewide need and is coordinated by the roadside vegetation management staff at OSU. The two-day school is followed by a half day of testing by the ODAFF. Once certification has been achieved, it would then be important for the new certified applicators to attend yearly continuing education workshops held during the winter of each year (January – April).

## **9.2.2 Continuing Education of Certified Applicators**

Initial certification provides the basics and helps prepare an applicator for future applications and pesticide applicator continuing education (CEU) workshops. The tremendous amount of information on plant, soil and weed science covered in initial schools will be applied to individual roadside vegetation management programs during the CEU workshops. Continuing Education Workshops are conducted each winter at field division headquarters. The information presented each year incorporates any new products, techniques, technologies, and regulations that have resulted in the past year. The workshops also continue to train on the important basics such as plant identification and safety issues. When appropriate, the workshops may include outside demonstrations of equipment calibration or new equipment. Participation is important at yearly workshops and comments are routinely solicited. Recommendations for future CEU topics from ODOT personnel are encouraged. The CEU workshop agenda will be developed annually by the RVM staff at OSU and will be submitted to the ODAFF each fall for prior approval and subsequent issuance of continuing education credits. Each certified ODOT applicator attending a workshop will receive credits which apply towards future recertification (exception: applicators can not accumulate credits in the same year of initial certification).

## **9.3 HERBICIDE APPLICATOR RECERTIFICATION**

After ODOT personnel successfully complete the certification exams and become a certified applicator, his/her personal certification is good for five (5) years or until the category recertifies (Table 9.1). At that time it is necessary to be recertified in whatever

categories apply to a particular applicator. In the state of Oklahoma, recertification is possible through two channels: (1) certified applicator retakes the written exams for each category or (2) certified applicator collects enough CEUs to qualify for recertification in a category without retaking the written exams.

**Table 9.1.** Recertification Information for Pesticide Applicators.

Category	Year's Category Recertifies	Total number of CEUs needed depending on the number of years between the year of certification and the year the category recertifies					Total number of CEUs that will count in any one year
		1 year	2 years	3 years	4 years	5 years	
6/Right-of-way	2009 2014 2019	3	6	9	12	15	7
5/Aquatic	2005 2010 2015	1	2	3	4	5	2
10/Demo & Research	2008 2013 2018	4	8	12	16	20	10
3/Ornamental & Turf	2009 2014 2019	4	8	12	16	20	10

Oklahoma was one of the first states, and ODOT one of the first entities, to implement this progressive program aimed at assisting certified applicators in keeping up-to-date in their field and in crediting them for their initiative and motivation for self-improvement.

Sometime during the year of recertification, all certified applicators should receive a notice from the ODAFF. The notice will have a list of accumulated CEUs to date, plus the number of CEUs needed by the end of the year to qualify for recertification. Later that same year, all applicators who have successfully accumulated enough credits will

receive an application from the ODAFF to recertify in a particular category. The application must be filled out and returned before ODAFF will issue a new certification card good for another 5-year period. As a government employee, ODOT personnel do not have to pay for recertification but they must return the application. It would be a good idea to photocopy and file all applications.

#### **9.4 HERBICIDE APPLICATOR TRAINING RECORD KEEPING**

The official records for all certified applicators are maintained in Oklahoma City by the ODAFF Consumer Protection Division. They also maintain all of the official continuing education attendance records. The roadside vegetation management team at OSU also maintains a record of all ODOT certification exam scores and continuing education workshop attendance. The records maintained at OSU are limited to testing and workshop attendance records for personnel participating at events produced by the RVM team at OSU. OSU training records may not reflect any training by ODOT personnel who attempt certification exams on their own or attend a continuing education program produced by someone other than the OSU team. ODOT personnel should take advantage of any and all herbicide training they have access to, but they should realize these records will be maintained by the ODAFF and not OSU. The OSU team would encourage all ODOT personal to send exam scores and dates and copies of CEU attendance forms from other training efforts to the OSU team to include in their database.

## **CHAPTER 10.0 HERBICIDE APPLICATION EQUIPMENT**

### **10.01 PURPOSE**

The purpose of this chapter is to overview herbicide application systems, components, system operating parameters, troubleshooting procedures and system maintenance.

### **10.05 INTRODUCTION**

An important component of ODOT's roadside vegetation management program is the herbicide application equipment. By proper selection, maintenance, and use of application equipment, potential problems can often be prevented such as drift, non-uniform coverage, failure of the herbicide to reach the targeted weeds and exposure to non-target areas.

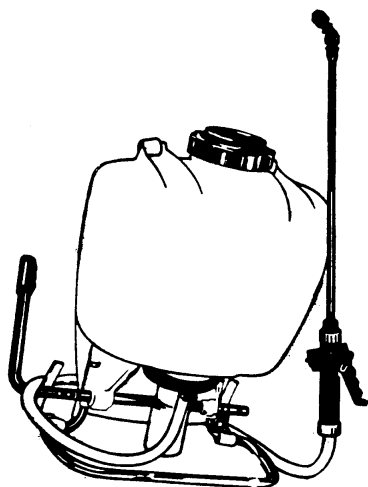
### **10.1 SPOT TREATMENTS (LOW VOLUME)**

Small capacity hand-held sprayers and backpack sprayers are very useful in making spot treatments (low volume) in many right-of-way areas. They are well suited for treating individual brush (stems) and for basal and cut surface applications. Tank capacity will usually range up to 5 gallons (18.9 liters). These sprayers can be fitted with a single nozzle or with a boom equipped with up to 3 nozzles (spray tips). Some types are filled to about three-fourths of the tank capacity with liquid and then air is pumped into the remaining space. They are commonly referred to as "pump-up" small capacity sprayers. The initial pressure may range from 30 to 60 psi (207 to 414 kPa)

but will continually drop as the spray is applied unless some type of pressure regulator is utilized.

Other backpack type sprayers (such as the Solo Deluxe) have a lever that is pumped during the spraying operation to activate a plunger or diaphragm pump (Figure 10.1). They have a small air chamber to reduce the surging of the spray mixture as the lever is pumped. The boom can be equipped with a pressure gauge so that a nearly constant pressure can be maintained while spraying.

This type of application equipment may be utilized to apply glyphosate for cut stump brush treatments or Garlon 4 Ultra® plus an oil carrier for making cut surface or dormant basal applications on targeted brush species along roadsides in Oklahoma (refer to Section 5.11 and 5.12). Calibration of hand-held herbicide application equipment for making spot treatments is discussed in Section 11.2.

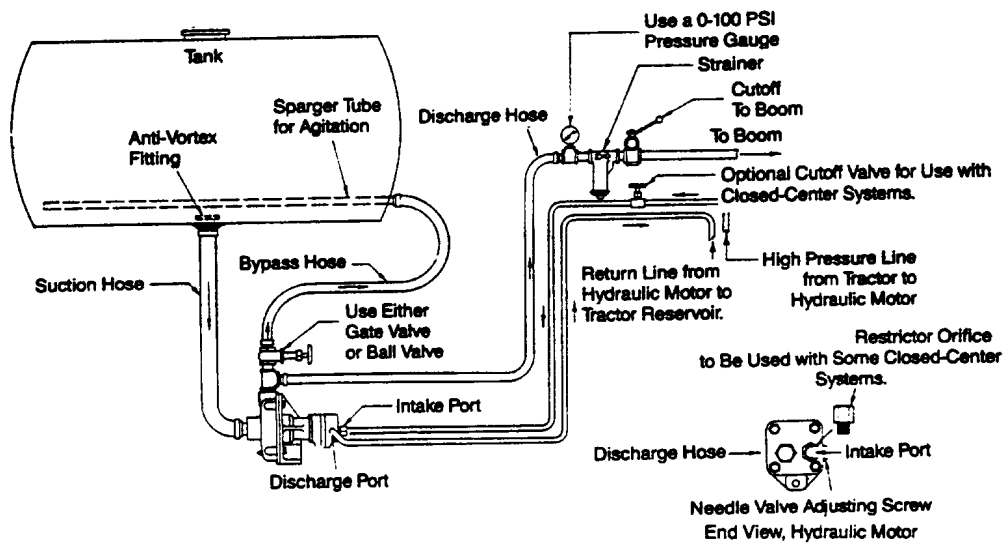


**Figure 10.1.** Backpack Sprayer Used For Making Spot Herbicide Treatments.

## 10.2 BASIC POWER SPRAYER DESIGN

The roadside sprayer is an integral component of the herbicide application equipment which ODOT uses to manage vegetation along roadsides in Oklahoma. Its primary function is to deliver the proper amount of herbicide/water mixture uniformly over the target area. Water is used as the means of carrying the herbicide to the target area with power spraying equipment. The basic components of power sprayer design include a tank, pump, agitator, strainers (filters), hoses, spray tip(s), valves and drift control injector (optional) (Figure 10.2).

### INSTALLATION DIAGRAMS



**Figure 10.2.** Basic Spraying System With Hydraulic Motor Driven Centrifugal Pump.

### 10.2.1 Tanks

The sprayer tank holds the herbicide/water mixture and must be constructed with a material that is resistant to potential corrosion from certain herbicide formulations.



Suitable materials include stainless steel, polyethylene plastic and fiberglass. Since some herbicides will corrode aluminum, galvanized and steel tanks, the use of tanks made with these materials should be avoided.

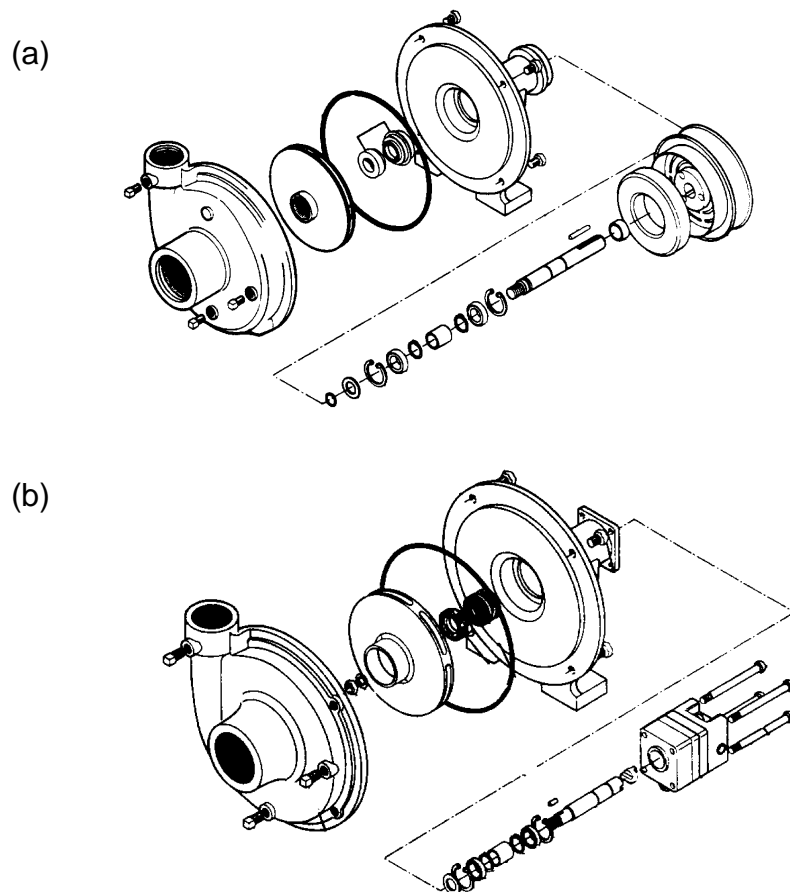
The filler opening of the tank should be large enough to easily fill and inspect the tank for cleanliness. The cover should form a watertight seal when closed to avoid spills. Some tanks may be equipped with a screen just under the filler opening to remove foreign material during the filling operation. By state law, during the filling process, an air gap or other means to prevent back-siphoning from occurring must be utilized. This can be achieved by mounting a support device onto the tank to hold the water hose above the filler opening. In most cases, ODOT will mount the filler (water) hose onto a permanent stand anchored to the ground. This method holds it in such a position above the tank creating an air gap which prevents back-siphoning. Sometimes overlooked are tank capacity or volume level markings, which must be accurate to insure the correct amount of water can be added. Many tanks have capacity marks located so that they are visible from the operator's position. On metal or sometimes fiberglass tanks, a clear plastic tube called a protected sight gauge, with a bottom safety shutoff valve, is mounted for determining fluid level. All tanks should have a bottom drain or a drain plug at their lowest point to allow the tank to be emptied completely.

### **10.2.2 Pumps**

The heart of the sprayer system is the pump. It must deliver the necessary flow to the nozzle(s) at the desired pressure to insure proper application. It is recommended that pump flow capacity should be 20% greater than the largest flow rate required by the

nozzle(s) and hydraulic agitation to compensate for pump wear. Types of pumps used to spray herbicides include roller, piston, diaphragm and the most commonly used for roadside applications in Oklahoma; the centrifugal pump (Figure 10.3). Each has its own unique characteristics making it well adapted for a particular situation. Piston and roller pumps are considered positive-displacement pumps, that is, the volume of output per revolution is always the same, regardless of speed or pressure. However, in contrast, the output per revolution of centrifugal pumps varies with speed or pressure. Diaphragm pumps are semi-positive displacement pumps. For purposes of this manual, only the operation of the more commonly used centrifugal pump will be discussed.

Centrifugal pumps generate pressure and flow via centrifugal force by creating a low pressure at the center and a high pressure at the outer edge of the pump impeller wheel. They operate on a pressure differential basis to generate flow. The single stage centrifugal pump is the most popular type pump for low-pressure roadside sprayers which ODOT uses. Both hydraulic fluid driven and auxiliary gasoline engines are used by ODOT to power centrifugal pumps. These pumps are simply constructed, durable and can readily handle wettable powders, dry flowables, water dispersible granules, and liquid herbicide formulations. They are capable of delivering flow rates which range from 30 to 150 GPM (114 to 568 LPM) (depending on pump size) with pressures from 25 to 40 psi (172 to 276 kPa) up to 70 psi (483 kPa) at 3000 to 4500 RPM.



**Figure 10.3.** Cutaway View Of Centrifugal Pump; (a) Belt-Driven And (b) Hydraulic-Driven.

### 10.2.3 Agitators

An agitator or agitation system is required to mix the components of the spray mixture uniformly and keep them mixed. Soluble liquid formulations (such as glyphosate) and soluble powders do not require constant agitation once in solution. However, continuous agitation for some herbicide formulations such as emulsions, wettable powders, or liquid or dry flowables is required. Constant agitation is needed to keep these herbicide formulations in suspension or they will tend to separate or settle out within the sprayer tanks. Separation (or settling) causes the herbicide concentration

to vary greatly within the spray tank resulting in potentially undesirable weed control and possible injury to desirable plant species.

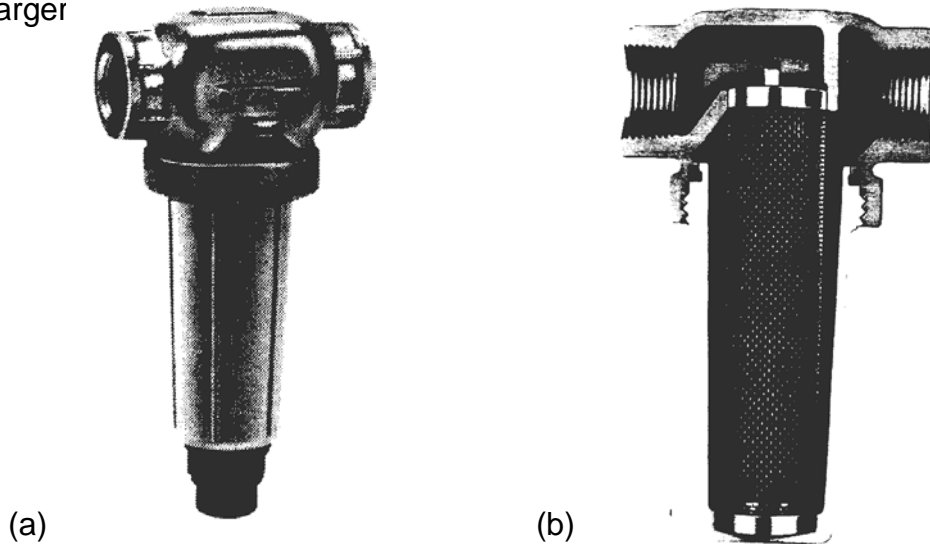
Mechanical agitators are propellers or paddles mounted on a shaft near the bottom of the spray tank. They are generally operated at 100 to 200 RPMs. This is the best type of agitation system to utilize when mixing the herbicide formulations which require constant agitation such as the wettable powders.

Hydraulic agitation, commonly referred to as bypass agitation, involves discharging a portion of the pump output from the pressure side of the pump through tube openings along the tank bottom or through special venturi injector agitator nozzles. On many of the ODOT sprayers, this type of bypass agitation is developed by mounting a “sparge” tube near the bottom of the tank (Figure 10.2). This tube has a series of holes drilled in it so that it creates the agitation necessary to keep the herbicides suspended adequately during the spraying operation. Properly designed and functioning sparge tubes should run the length of the tank and are very important when using all ODOT herbicides, especially dry formulations.

#### **10.2.4 Strainers**

The herbicide spray mixture needs to be filtered properly with the use of strainers which are a type of filters (Figure 10.4). This not only protects the working parts of the spraying system but also avoids the potential of misapplication due to the nozzle tip(s) clogging. Strainers are classified by mesh numbers which indicate the number of openings per square inch. Strainers with high mesh numbers have smaller openings than strainers with low mesh numbers. For example, a 50-mesh strainer will catch

smaller foreign particles than a 20-mesh strainer. There are three types of strainers commonly used on sprayers; tank filler (opening), in-line and nozzle. As the herbicide spray mixture moves through the sprayer system, the strainer size openings (mesh) should become progressively smaller. A 10- to 20-mesh strainer is recommended for the tank filler opening. For centrifugal pumps, an in-line strainer of 5- to 10-mesh, but no smaller than 20-mesh is recommended. This strainer should be placed on the suction side of the pump between the pump and the spray tank. It should be cleaned frequently (daily) and have an effective straining area several times larger than the cross-section area of the suction line. A 20-50 mesh nozzle screen may sometimes be used on the pressure side of the pump to insure that the nozzle(s) does not clog. However, with the use of many solid-stream tips, Boom-Buster® tips or off-center nozzles, a strainer is usually not used or sometimes not even recommended for use because of the larger



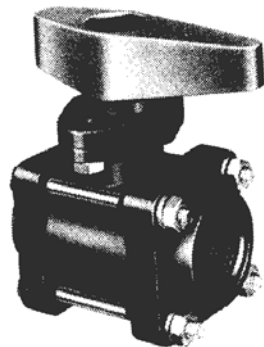
**Figure 10.4.** Spray System Strainer; (a) Exterior View and (b) Cut-Away View Showing Strainer Mesh.

### **10.2.5 Hoses**

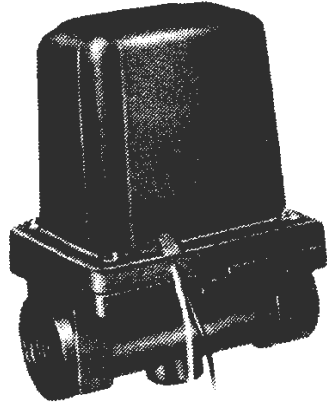
The use of synthetic rubber or plastic hoses (high pressure types) having a burst strength greater than the peak operating pressure of the sprayer system is recommended. This high pressure hose will usually have a bursting pressure of 200 psi or greater. The use of any other type hoses, such as garden hose, is discouraged. Hoses or sprayer lines must be properly sized for the system, flexible, durable and be resistant to oils and solvents in herbicide formulations. They must also be weather resistant (i.e. to sunlight, ozone, etc.) and resistant to general abuse such as twisting, pulling, shock load or “hydraulic hammer” effects and vibration. The suction line can often be the source of pressure problems. It must be airtight, non-collapsible, as short as possible and have an inside diameter as large as the pump intake. A collapsed suction hose will restrict flow, starve or cavitate a pump causing damage to pump seals. There should be as few restrictions and fittings as possible between the pump and the nozzle tip(s). Proper line and hose size will vary with the size and capacity of the pump and nozzle(s) size. A high, but not excessive, fluid velocity should be maintained throughout the system. When using centrifugal pumps, it is recommended that the inside diameter of the discharge hose be the same size as the output side of the pump. This hose I.D. should be maintained and routed as close to the nozzle tip(s) as possible and should be kept short as possible. This maximizes the efficiency of the pump (and bypass agitation) while minimizing friction loss in the lines or hoses.

## 10.2.6 Valves and Pressure Gauges

The major component of the sprayer flow control system is a pressure shut-off valve or a throttling valve. It directs the flow of the spray mixture and insures sufficient flow reaches the nozzle tip(s) at the desired pressure. The output of a centrifugal pump is regulated by a throttling valve which is basically a simple gate or globe valve (Figure 10.5). A pressure regulating valve on this type of flow system is not required. For accurate pressure control, a special throttling valve requiring several turns to open completely, should be used. Electrically controlled throttle valves are also commercially available which permit remote operation. These valves are usually mounted in such a manner as to allow the remaining discharge or excess flow from the pump (other than what is necessary for application) to be used for bypass or hydraulic agitation in the system. A second valve, commonly referred to as a “shutoff valve,” is activated by an electric solenoid that is operated remotely by the applicator (Figure 10.6). This valve is mounted on the output or discharge line near the nozzle tip(s) to turn the sprayer on or off. It is imperative that this valve be operating properly (not leaking) to avoid misapplication on rights-of-way near sensitive areas.

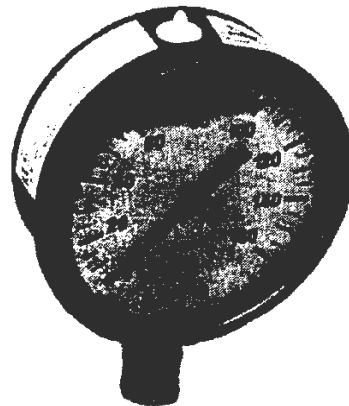


**Figure 10.5.** A Throttle Valve.



**Figure 10.6.** A Shutoff Valve Activated by an Electric Solenoid.

A pressure gauge is an integral part and a “must” of every spray system to correctly indicate an accurate pressure at the nozzle tip(s). A liquid filled pressure gauge, with a maximum reading of 100 psi, is recommended for use on ODOT spray rigs (Figure 10.7) and should be mounted as close to the nozzle tip(s) as possible. This provides a more accurate pressure reading during the spraying operation and especially during the calibration process. If one is selecting a pressure gauge which isn’t liquid filled, be sure the internal parts are constructed of materials that will resist corrosion from the spray mixture.



**Figure 10.7.** A Liquid Filled Pressure Gauge Is Used To Monitor Spray System Pressure.



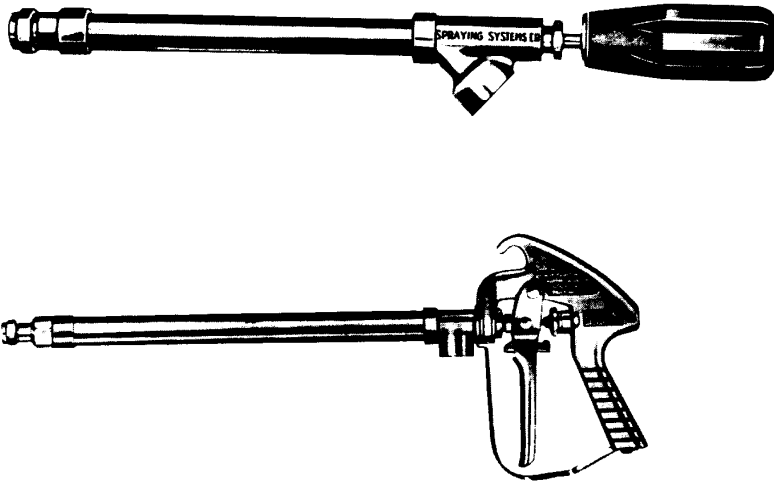
### **10.2.7 Nozzles**

Nozzle (tip) selection is one of the most important factors affecting the performance of herbicide application equipment when treating roadsides. The nozzle type determines the uniformity and volume of the spray mixture applied, the completeness of coverage and the amount of drift. Although many nozzle types are available, each one is designed for specific purposes. The more common types preferred by ODOT for roadside rights-of-way spraying include the regular flat-fan (for boom-type applicators), Boom-Buster®, solid-stream and off-center. These will be covered in more detail in Section 10.6.

There are a variety of materials used to manufacture nozzle tips. Brass tips are the most common and inexpensive. However, they wear rapidly, especially when using wettable powder formulations. This wear leads to improper application rates and poor spray patterns. Stainless steel or hardened stainless steel tips are non-corrosive and resistant to abrasion. These tips are recommended because they will usually provide the best performance for the price paid. A new design recently manufactured is a nylon tip with a stainless steel insert. This design offers an alternative to solid stainless steel tips at a reduced cost.

### **10.3 Handgun Treatments (High Volume)**

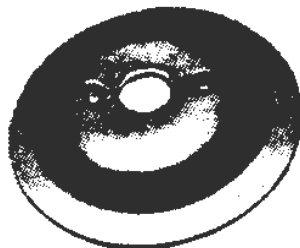
The handgun is one of the most versatile and common types of herbicide application equipment (Figure 10.8). It can be utilized to treat accessible as well as inaccessible roadside sites which require either a spot or broadcast type of treatment.



**Figure 10.8.** Commonly Used Hand Spray Guns For Applying High Volume Herbicide Treatments.

It can be attached to any size reservoir (spray tank) with any length of hose. The handgun is usually equipped with a disc tip to produce a solid stream pattern (Figure 10.9). These discs are usually made of materials which resist abrasion. When using a handgun, it is recommended that the device be adjustable so that the spray pattern can be changed from a solid stream to a wide cone pattern with an internal core. Droplet size is determined by the amount of pressure on the sprayer system and size of the (spray tip) orifice. The overall pumping pressure on the sprayer system available at the handgun is determined by the length and size (inside diameter) of the hose used. The handgun is generally used to make a high volume application with carrier rates at 50 GPA (467 LHa) to 250 GPA (2338 LHa) or greater. As referenced in Chapter 4, a handgun can be utilized to apply a post-emergent spot (guardrail) or broadcast treatment for summer and winter broadleaf weeds (Section 5.5), musk thistle (Section 5.6), Scotch thistle (Section 5.7), brush (Section 5.10) and for aquatic weed control

(Section 5.14). A disc tip with a smaller hole should be used to spot treat thistles, whereas a disc tip with a larger hole should be used to treat guardrails and brush.



**Figure 10.9.** A Disc Tip Used In A Hand Spray Gun For Producing A Solid Stream Pattern.

## 10.4 BROADCAST TREATMENTS

Broadcast herbicide applications are the most common method that ODOT uses to treat the majority of roadside rights-of-way in Oklahoma. As the name implies, when making a broadcast application, the full width of the spray swath or pattern is treated with the herbicide spray mixture at a uniform rate. The width of the spray pattern is determined primarily by the nozzle tip size and the sprayer pressure. The most common type of broadcast application is made utilizing boomless nozzles (tips). These include using the Boom-Buster®, solid-stream and off-center nozzles which will be covered in more detail in Section 10.6. The spray pattern produced by most of these boomless nozzles is somewhat flat and arc-shaped. A fairly uniform application rate is produced across the spray pattern width. The major advantage of using boomless nozzles to make broadcast herbicide applications is the ability to spray from the somewhat smooth surface of the paved shoulder and not having to traverse the area to be treated. Boomless broadcast spraying enables the applicator to spray to the side of the equipment and avoid a variety of roadside obstructions such as guardrails,

signposts, delineators, etc. This results in a more uniform speed and a better job of applying the herbicide to the targeted area. The major disadvantage of using boomless application equipment is the potential drift problems occurring during application.

Two other types of nozzles that ODOT may use on a very limited basis to make roadside broadcast applications include the flat-fan spray tip(s) and the wide angle or flood tips. Both will be discussed in more detail in Section 10.6. These nozzles are usually mounted on what is commonly referred to as a spray boom or spray bar on a boom-type sprayer. The boom-type sprayer consists of a spray bar or boom, usually several feet in length, on which are attached several flat-fan or flooding flat-fan nozzle tips. The advantage of using boom-type sprayers is that good spray coverage of the treated area can be achieved. The major disadvantage of using these sprayers is that they must traverse the area to be treated. This reduces the efficiency and productivity of the spraying operation, mainly due to the slow speeds used with this type of sprayer and in rough or uneven terrain a spray rig cannot access certain areas. If set up properly, the boom sprayers have little problem with drift.

## **10.5 SPRAY SYSTEM PRESSURES**

Spray system pressures not only affect the amount of physical drift which may occur during the spraying operation (Section 4.5), but also directly affect the size of spray droplets. Regardless of what type of spray nozzle tip is utilized, there is an optimum range of pressures recommended by the manufacturer that maximizes the efficiency of that particular tip. Exceeding the recommended pressure of a specific nozzle tip reduces the droplet size, thus increasing the potential for physical drift to

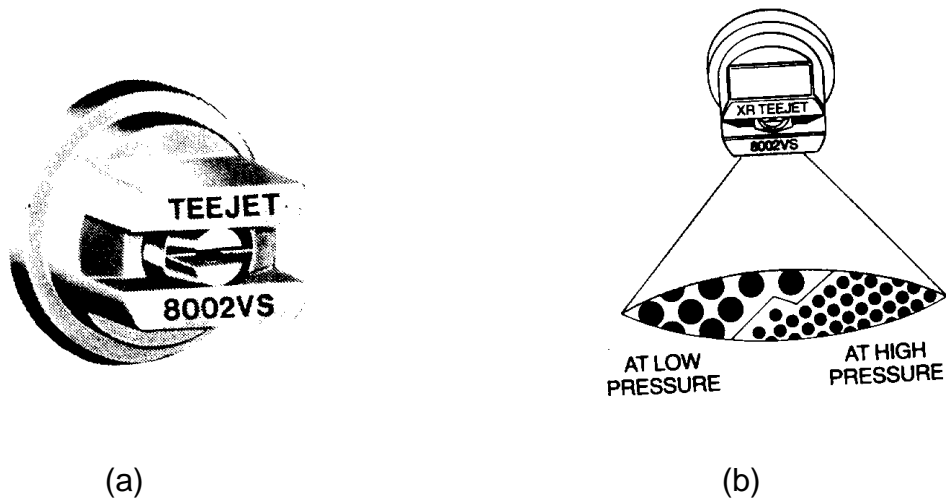
occur. Excessive spray pressures, usually greater than 30 psi (207 kPa), begin to atomize (make smaller) spray particles. One should always remember that the lower the operating pressure used, the less chance for particle drift. Lower pressure results in less spray mixture delivered while higher pressure results in more spray mixture being applied. Once a sprayer is calibrated, changing pressure is not a recommended, nor a good method to change sprayer output. Changing the pressure on the sprayer system will change the nozzle pattern and spray droplet size. Because pressure is a square root term, it must be increased four times to double the flow rate of a specific nozzle tip. As a result, changes in pressure will have minimal effect on the flow rate. If a major change is needed to the flow rate of the tip, then it is recommended that one change the nozzle tip size to obtain the desired effect. Section 4.6, Part III of this manual addresses ODOT's Herbicide Program Policy with regards to pressures to be used with specific types of herbicide application equipment. This policy states that operating pressures "shall not exceed 206.84 kPa (30 psi) when making broadcast applications with a solid-stream nozzle and shall not exceed 172.375 kPa (25 psi) when making broadcast applications with a fan type nozzle." A fan type nozzle would include flat-fan nozzles and Boom-Buster® nozzle tips. This policy further states that "when utilizing a handgun-type application method, follow label instructions for appropriate application pressures." Unless making a foliar application targeting specific brush species with a handgun (which requires higher operating pressures), pressures should rarely exceed 20 to 30 psi (138 to 207 kPa) when using herbicide application equipment such as the Solo backpack sprayer. Normally 20 to 25 psi (138 to 172 kPa) is more than adequate to obtain the desired spray pattern.

## **10.6 NOZZLE TIPS AND SIZES FOR ROADSIDE HERBICIDE APPLICATIONS**

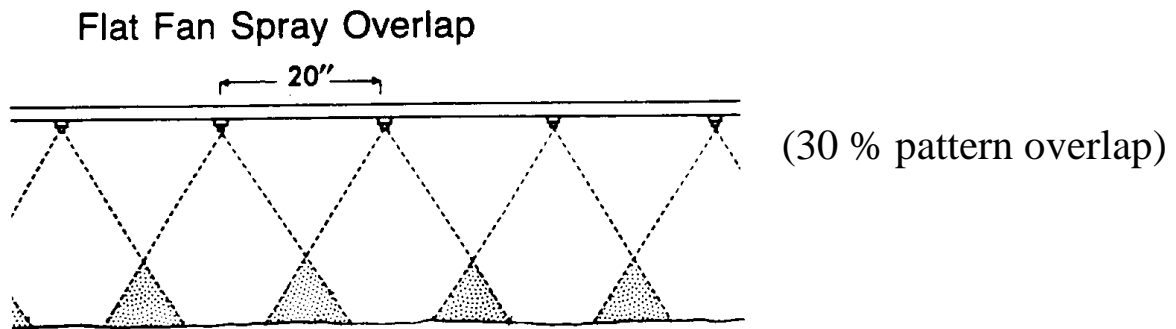
As previously mentioned in Section 10.2.7, there are several nozzle types of various sizes available for roadside herbicide applications. These include the flat-fan, Boom-Buster®, solid-stream and off-center.

### **10.6.1 Flat-Fan Nozzle Spray Tips**

For boom-type broadcast herbicide applications, the nozzle tips often preferred are either the regular flat-fan or the flooding type spray tip. The regular flat-fan spray tip (Figure 10.10a) is one of the most commonly used for boom application of herbicides. It produces a flat spray pattern with tapered edges (Figure 10.10b). Because the outer edges of this pattern receive less volume, spray patterns from adjacent tips must be overlapped 30% for flat-fan tips. Flat-fan nozzles are usually spaced 20 inches (50.8 cm) apart on the boom (Figure 10.11). Height of the boom above the target varies with fan angle. Closer or wider spacing is possible and may be compensated for by raising or lowering the boom. The more common tips that are available include those with spray angles of discharge of 65, 80 and 110 degrees. Uniform application with these types of tips on a spray boom require that nozzles are evenly spaced, all nozzles have the same fan angle and flow rate, and the boom is parallel with the ground. The normal operating pressure for most flat-fan nozzles may range from 15 to 60 psi (103 to 414 kPa), however, low-pressure, flat-fan nozzles can operate at pressures from 15 to 20 psi (103 to 138 kPa) very effectively.



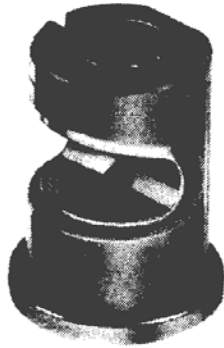
**Figure 10.10.** A Regular Flat-Fan Spray Tip (a) Produces A Flat Pattern Tapered At The Edges (b) [Above].



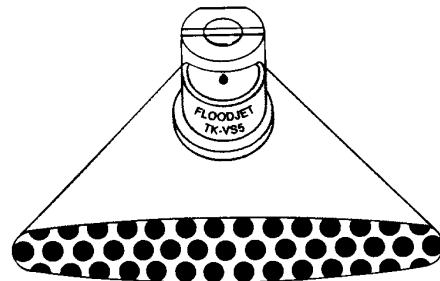
**Figure 10.11.** Spray Patterns From Adjacent Nozzles Must Be Overlapped To Produce Uniform Spray Coverage [Above].

The flooding flat-fan nozzle tips (Figure 10.12a) produce a wide-angle flat spray pattern (Figure 10.12b), usually from 115 to 125 degrees in angle. They can be operated at very low pressures from 10 to 25 psi (69 to 172 kPa) (optimum range) while producing large spray droplets. The nozzle spacing should be less than 60 inches (152.4 cm), with 40 inches (101.6 cm) being recommended (Figure 10.13). Pressure changes on flooding flat-fan spray nozzles affect the angle and width of the spray pattern more than on the regular flat-fan nozzles. The width of the spray pattern increases as pressure increases. The discharge can be directed horizontally backward

for a uniform pattern or downward for minimum drift potential. The best compromise position is backward or tilted at a 45-degree angle with the soil surface (Figure 10.14). Spray patterns should overlap 100% for uniform distribution, therefore, the area sprayed by one nozzle should be twice as wide as the nozzle spacing. Boom height is adjusted until this overlap is achieved.



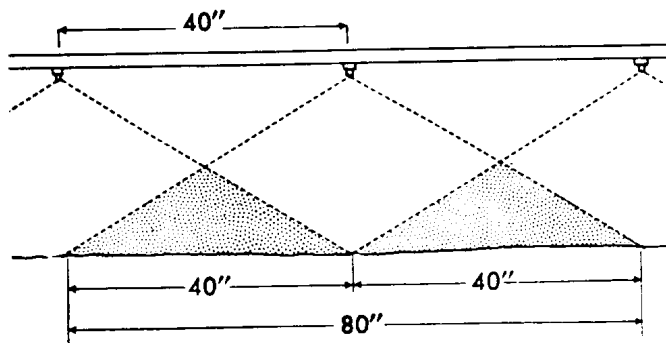
(a)



(b)

**Figure 10.12.** Flooding Flat-Fan Nozzles (a) Produce A Wide-Angle Flat Spray Pattern (b) [Above].

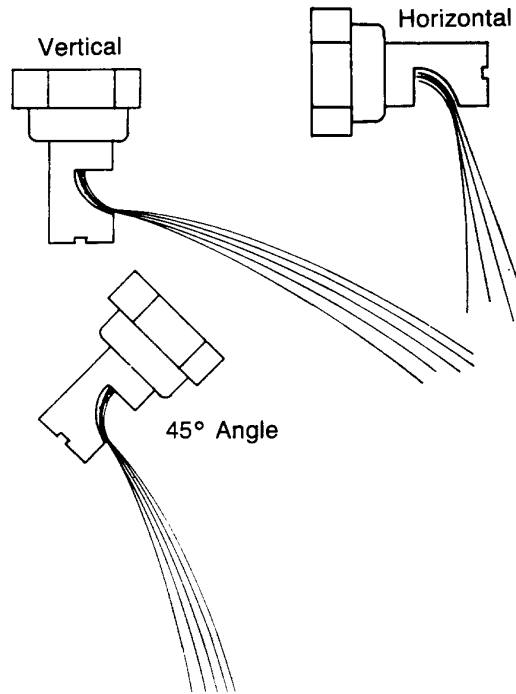
**Flooding Nozzle Spray Overlap (100 Percent)**



**Figure 10.13.** Recommended Nozzle Spacing On A Boom Containing Flooding Flat-Fan Nozzles Is 40 Inches In Order To Achieve 100% Pattern Overlap [Above].



### Flooding Nozzle Operating Positions



**Figure 10.14.** Flooding Nozzle Operating Positions of Vertical, Horizontal and 45 Degree Angle.

### 10.6.2 Boom-Buster Spray Nozzles

One of the more recent designs in boomless spray nozzle tip technology is the Boom-Buster® spray tip (Figure 10.15). Similar to the arc-shaped spray pattern produced by the off-center spray tip, the Boom-Buster® tip provides a more uniform spray distribution across its spray width (pattern). Boom buster tips produce a more major advantage when compared to the conventional off-center spray tip. Boom buster nozzles have been designed so that they can be used alone or in combination with other specific Boom-Buster® nozzle tips. Figure 10.16 supplies information on suggested nozzle combinations for a specific range of desired speeds and spray widths. As recommended by the manufacturer, when ordering right-of-way nozzles, the letter

“R” needs to be added to the specific nozzle model number. Right-of-way Boom-Buster® nozzle tips spray beneath and slightly behind the nozzle. Standard nozzles (those without an “R”) spray beneath and further behind the nozzle to insure overlap when two nozzles are mounted back-to-back. A very efficient and effective roadside sprayer head incorporates a three-nozzle combination as opposed to using a single nozzle tip for roadside spraying. Ideally a boomless roadside sprayer should include a 260-11R, 375-R, and 437-R Boom-Buster® nozzle model numbers. Each of these nozzles, when used alone, is designed to spray a specific pattern width with the 260-11R tip spraying 11 feet (3.4 m); the 375-R spraying 21.5 feet (6.6 m); and the 437-R tip spraying up to 29.5 feet (9.0 m). One of the major advantages of using a combination of three Boom-Buster® nozzles is that the desired spray pattern width is flexible or adjustable as the need arises while the applicator drives along the highway rights-of-way (Figure 10.17). An additional advantage is the ability to spray from the smooth surface of the roadside shoulder without having to traverse the area being treated. These three nozzles, when operated independently from each other (one at a time), will apply the same rate of spray mixture, when operated at the same speed and at the same pressure. The manufacturer suggests that the Boom-Buster® nozzles be operated at 40 psi (276 kPa), however, ODOT’s Herbicide Program Policy restricts the maximum operating pressure to 25 psi (172 kPa). Boom buster tips produce perfectly good and uniform patterns when operating at 25 psi and the lower pressure helps reduce the number of small spray particles which helps minimize drift. As with most other types of boomless sprayers, drift from windy conditions is still a problem when

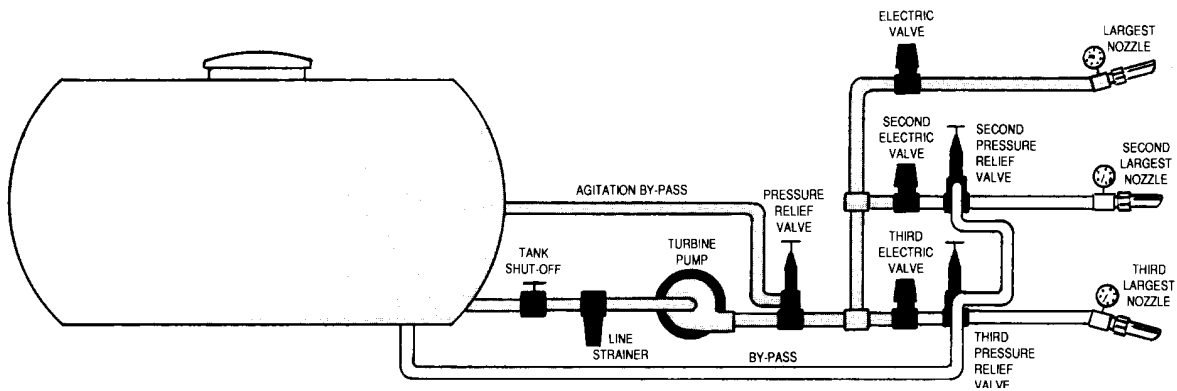
using this particular nozzle tip(s); but because of the reduced number of fine particles drift is minimized.



**Figure 10.15.** The Boom-Buster Spray Tip [Above].

NOZZLE COMBINATIONS FOR SPEEDS FROM 4 TO 10 MPH			
<b>MOD 120-5R</b> Band Width 5 Ft.	<b>MOD 180-10R</b> Band Width 10 Ft.	<b>MOD 265-R</b> Band Width 19.5 Ft.	
NOZZLE COMBINATIONS FOR SPEEDS FROM 7 TO 15 MPH			
<b>MOD 180-6R</b> Band Width 6 Ft.	<b>MOD 260-11R</b> Band Width 11 Ft.	<b>MOD 375-R</b> Band Width 21.5 Ft.	<b>MOD 437-R</b> Band Width 29.5 Ft.
NOZZLE COMBINATIONS FOR SPEEDS FROM 16 TO 30 MPH			
<b>MOD 260-5R</b> Band Width 5 Ft.	<b>MOD 370-R</b> Band Width 10 Ft.	<b>MOD 500-R</b> Band Width 20 Ft.	

**Figure 10.16.** Matching Boom-Buster® Spray Tips To Ground Speed And Pattern Width [Above].



**Figure 10.17.** A System Using Three Different Boom Buster Tips Allows For Flexibility.

### 10.6.3 Solid-Stream Spray Nozzles

Another type of nozzle used for boomless broadcast herbicide applications on roadsides is the solid-stream spray nozzle tip (Figure 10.18). Solid-stream nozzles produce a solid stream similar to water coming out of a pipe and are most often used in conjunction with 10, 15 and 20 degree Veejet tips. By design, these nozzles are used to treat a specific section or part of a spray pattern. For roadside rights-of-way application, they are most commonly used as a cluster of nozzle tips with Veejet tips used closer to the spray head and solid-stream tips used for treating the outside portion of the spray pattern. Each part of the cluster (usually composed of several tips) is set to treat a defined section of the right-of-way. The major advantage in using this type of boomless applicator is that the spray pattern width or swath is flexible or adjustable by turning specific nozzle clusters off and on with the use of an electric solenoid switch or valve. Also, another major advantage, as with the cluster nozzles, is the ability to spray from the smooth surface of the roadside shoulder without having to traverse the area to be treated. ODOT's Herbicide Program Policy (refer to Section 4.6, Part III) allows an operating pressure of up to 30 psi (207 kPa) for this type of boomless applicator. The main disadvantage of using this type of nozzle is that wind will still tend to distort the

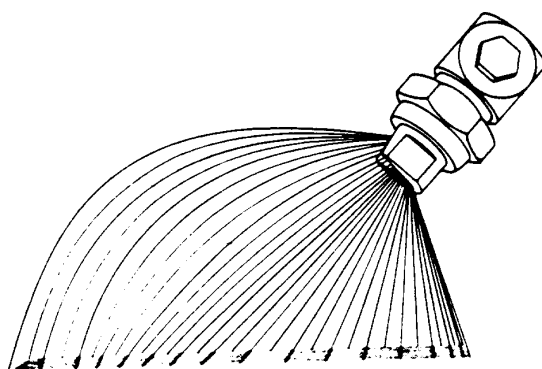


**Figure 10.18.** The (a) Solid-Stream Nozzle is Used for (b) Boomless Broadcast Herbicide Applications.

spray pattern somewhat, but not as much as with the off-center nozzle. Drift of fine spray particles is still a concern, however, solid-stream sprayers produce fewer fine particles when compared to off-center sprayers and are similar to Boom-Buster® sprayers.

#### 10.6.4 Off-Center Spray Nozzles

The use of the off-center (OC) spray nozzle was the most common method of applying herbicides along highway roadsides in Oklahoma until the late 1990s. Off-center nozzles produce a flat-fan spray pattern extending from one side of the nozzle tip (Figure 10.19). This allows spraying up to a 30-foot (9.1 m) spray swath without the use of a boom. This was the major reason ODOT began to use these nozzles in the late 1970s. The wide width of the spray pattern allowed spraying from the smooth roadside shoulder without having to traverse the area to be treated. At that time, the use of these nozzles significantly improved the efficiency and productivity of applying herbicides along roadsides.



**Figure 10.19.** The Off-Center Nozzle Is Used For Making Boomless Broadcast Herbicide Applications.

Spray droplets at the end of the pattern nearest the OC nozzle are smaller, and droplets get larger towards the end of the spray pattern most distant from the nozzle.

Drift is a major concern with these nozzles because of the wide range of droplet size. Spray coverage is relatively uniform when the nozzle is mounted at the proper height and operated within a pressure range of 15 to 25 psi (103 to 172 kPa) (Section 4.6, Part III). The major disadvantages of using off-center nozzles are: 1) the spray swath is fixed and non-adjustable, 2) wind or any air turbulence will distort the spray pattern, causing irregular or variable spray coverage of the targeted area, and 3) particle drift to off-target areas. These are the main reasons why ODOT has equipped most boomless sprayers with solid-stream or Boom-Buster® nozzles.

## **10.7 CHECKLIST FOR SPRAYER PROBLEMS**

As long as ODOT continues to use herbicides to manage unwanted roadside weeds, situations may arise where the applicator experiences problems with the sprayer equipment performing properly. The following steps are recommended to be followed prior to calibration and use of the herbicide sprayer. These steps are to serve as a guide in minimizing potential sprayer equipment problems. Also, refer to the publication “L-322 Boomless Roadside Herbicide Sprayer Assessment Guide” for additional information and pictures.

### Checklist Prior to Sprayer Operation

REMEMBER TO WEAR NITRILE GLOVES WHILE PERFORMING THESE PROCEDURES.

1. Rinse tank and fill it with clean water.
2. Clean all nozzle tip(s) and screens. Use only a soft bristle brush similar to a toothbrush. Do not clean nozzles with a pocket knife or other sharp or

hardened objects. Check nozzle tip(s) to make sure they are spraying properly and producing the desired spray pattern (and width).

3. If using a sprayer equipped with several nozzle tips (such as the Solid-Stream Estes Spray Head), check to be sure that all tips are of the appropriate size and are discharging equal amounts of water. If any tip should vary more than 10% from the manufacturer's suggested rate, it should be replaced.
4. Run the sprayer to flush all hoses and booms, if appropriate, **without the spray nozzle tips(s) in place.**
5. Replace the nozzle tip(s) on the spray boom, if appropriate. Run the sprayer and check for leaks throughout the system and repair if needed.
6. With the appropriate nozzle tip(s) operating, adjust the engine speed (RPM) on the truck while adjusting the flow control valve to obtain the proper hydraulic fluid flow through the hydraulic fluid driven centrifugal pump to obtain the desired pressure on the system. An alternative method is to adjust the speed (RPM) on the auxiliary engine which drives the centrifugal pump in order to obtain the desired spray pressure.
7. Once steps 1-6 are completed, the sprayer may be calibrated (refer to Chapter 11 for specific calibration procedures to follow).

During the actual application operation, if a sprayer problem should arise, the following troubleshooting guide may be helpful in solving the problem.

## TROUBLE SHOOTING GUIDE

1. No delivery of spray liquid through the nozzles.  
Check for:
  - a. Empty tank.
  - b. Clogged lines, screens or nozzle tips.
  - c. Sharp kinks in hoses.
  - d. Tank vent closed.
  - e. Improper or poor mixing of herbicide(s).
  - f. Pump failure.
  - g. Pressure regulator failure (if one is used).
  
2. Fluctuating pressure.  
Check for:
  - a. Material in supply tank is low.
  - b. Dirty screens.
  - c. Debris in the seat of the pressure regulator (if one is used).
  - d. Pump drive slipping (if using auxiliary engine).
  - e. Trash in pump.
  - f. Hydraulic fluid too hot and not adequately cooled (if using hydraulic fluid driven centrifugal pumps).
  
3. Excessive abrasive action in the pump.  
Check for:
  - a. Sand, grit, dirt or crystals.
  - b. Failure to use suction trainer.
  - c. Poor agitation of chemicals or mixtures containing solids.
  
4. Starved pump.  
Check for:
  - a. Shut-off valve to pump is closed.
  - b. Too small of a suction hose or pipe.
  - c. Leaks in suction line.
  - d. Collapse in suction hose.
  - e. Kinks in suction hose.
  - f. Too long of suction.
  - g. Too high suction lift.
  - h. Stopped up in-line strainer.
  - i. Worn pump.
  
5. Dry Pump (no flow or liquid in pump).  
Check for:
  - a. Running pump too long a period without liquid.
  - b. Running pump too long while trying to prime the pump.
  - c. Points mentioned in number 4 above.



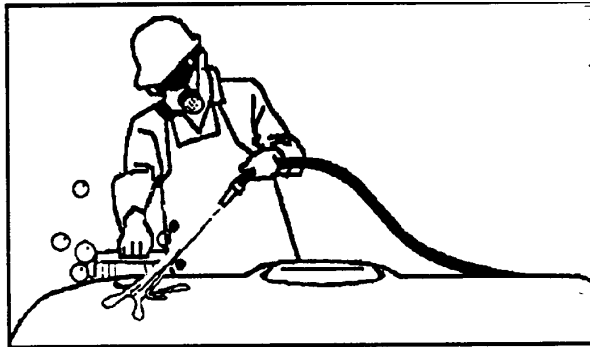
## 10.8 Proper Sprayer Cleaning, Storage and Maintenance Procedures

It is an important responsibility of the ODOT herbicide applicator (or other such designated person) to learn and understand the importance of proper procedures in cleaning, storage and maintenance of roadside sprayer equipment.

### 10.8.1 Cleaning Herbicide Sprayer Equipment

Both the outside and inside of the sprayer equipment requires regular cleaning to

prevent an accumulation of herbicide residue. It is not recommended that an herbicide/water spray mixture be left in the tank overnight as equipment corrosion may occur and some herbicides may tend to settle



out as well. Proper cleaning procedures will reduce corrosion potential and prevent possible contamination which may result in damage to desirable vegetation. When cleaning spray equipment, be sure the rinse water does not drain into areas of desirable vegetation or where it may contaminate water supplies or streams. Rinse water should be applied to roadsides or to ODOT gravel maintenance yards. Additionally, areas where spray equipment is cleaned should not be accessible to children, livestock, pets or wildlife. The following steps are recommended for thoroughly cleaning sprayers:

1. Completely hose down the spray tank, both inside and out. Flush the sprayer tank, lines, hoses, strainers and nozzle(s) thoroughly with clean

water. Apply the herbicide-contaminated rinsate to a labeled site such as roadsides or around ODOT yard.

2. Repeat the procedures given in Step 1.
3. A sufficient amount of water and detergent or water and ammonia should be added to the spray tank to insure the cleaning solution reaches all parts of the tank. Use 1 pound of detergent to 50 gallons of water (0.25 kg per 100 liters) or 1 quart of household ammonia per 25 gallons of water (1 liter ammonia to 100 liters water).
4. Flush the entire spray system with the cleaning solution. Hormone-type herbicides such as 2,4-D, Banvel or Vanquish can only be removed with ammonia.
5. Wash the tank and pump parts by running the spray for about 5 minutes and discharge a small amount either through the boom and/or nozzle tip(s).
6. If possible, let the cleaning solution remain in the sprayer overnight. (Please note: household ammonia will corrode aluminum sprayer parts).
7. Flush out the remaining ammonia-water solution through the nozzle tips by operating the sprayer or drain the sprayer completely.
8. Remove nozzle tips and strainers. Clean them in either an ammonia or detergent solution, using a soft brush. Do not use a knife, wire or other hard object to clean the nozzle tips. The precision-machined surfaces of the tips or nylon Boom-Buster® diffusers can be easily damaged causing

a distortion of the spray pattern, application errors and increase the potential for particle drift.

9. Fill the spray tank about half full of clean water while hosing down both the inside and outside, then flush out thoroughly through the boom and reassemble.
10. If this is the final cleaning before winter storage, make sure to winterize pumps, valves, hoses and all sprayer parts that could trap water, freeze and break.

### **10.8.2 Storage and Maintenance of Sprayer Equipment**

Prior to equipment storage over the winter season or at the end of the spray season the following steps are recommended (the primary goal is to remove all water from all sprayer parts and lubricate to prevent corrosion):

1. Clean the sprayer thoroughly before long-term storage. Use ammonia to decontaminate.
2. Use compressed air to blow water from hoses, valves, etc.
3. If possible remove spray heads (nozzles and valves) and store in a heated area.
4. If inside storage is not possible, store in a covered enclosure. If this is not possible, cover spray heads with tarps to prevent damage from sunlight.
5. Service all gasoline auxiliary motors by checking oil levels and putting stabilizer additives to gasoline or drain all gasoline from tank and carburetors for storage.

6. To winterize pumps use one of the following options: a) remove all water from pump by opening pump drain valve and using compressed air, then pour 2 ounces of lightweight oil into pump and turn pump several rotations to coat all of the inside surfaces, or b) using RV or marine antifreeze at full strength, fill pump or pump and lines completely to prevent freeze and corrosion damage.
7. Make sure the following spray season to flush the oil or antifreeze from pumps and lines before attempting to calibrate the spray rig.
8. Replace all damaged hoses, leaky valves or fittings, faulty solenoids and any other defective or severely worn components. On older systems, replace aged parts as a part of routine maintenance prior to their failure.

# **CHAPTER 11.0 HERBICIDE APPLICATION**

## **EQUIPMENT CALIBRATION**

### **11.01 PURPOSE**

The purpose of this chapter is to provide the reader with procedures for calibration of backpack sprayers, boom-type sprayers and boomless sprayers equipped with off-center, solid-stream or boom buster nozzles.

### **11.05 INTRODUCTION**

The purpose of calibrating a roadside herbicide sprayer is to insure that the equipment delivers the proper amount of herbicide uniformly over the targeted area in order to obtain the most effective and economical results. Consequently, proper sprayer calibration is a critical part of a successful roadside herbicide program. Unfortunately, calibration is the one step in herbicide application that can often be neglected and misunderstood. Oklahoma Department of Transportation personnel unfamiliar with appropriate calibration procedures should seek assistance from their supervisor or OSU RVM personnel (see contact information in Section 13.5).

### **11.1 FACTORS THAT INFLUENCE THE AMOUNT OF HERBICIDE APPLIED TO AN AREA**

There are four major variables which affect the amount of spray (herbicide/water mixture) applied to a given area. These include nozzle flow rate, carrier rate, ground speed and spray pattern width.

### 11.1.1 Nozzle Flow Rate

Nozzle flow rate is expressed as gallons per minute (GPM). This is the amount of herbicide/water mixture which is collected from a specific nozzle tip in one minute at a given pressure. The flow rate through a nozzle varies with the nozzle pressure and the size of the particular nozzle tip. Increasing the pressure or using a nozzle tip with a larger opening (orifice) will increase the flow rate. Increasing the pressure on the spray system does not give or result in a proportional increase in flow rate. For example, doubling the pressure will not double the flow rate from a particular nozzle tip. In order to double the output (or flow rate) of a particular nozzle tip, the pressure must be increased four times. An example to illustrate this point follows: At 25 psi, you collect 15 GPM; to double the nozzle flow rate to 30 GPM, the pressure would have to be increased to 100 psi. Therefore, the key point to remember is that pressure should not be used to make a major change in nozzle flow rate or delivery. It can be used to fine-tune or make minor changes. The most effective way to make a large change in nozzle flow rate is either to change the nozzle tip size or make a change in the ground speed of the sprayer. It should be remembered that operating pressure must remain constant or be maintained within the recommended range for the particular nozzle type in order to obtain a uniform spray pattern and minimize drift potential. Changes in nozzle tip size can significantly change sprayer output or flow rate and will likely require a change in carrier rate. It is recommended that the manufacturers' catalogs be used to help select the proper tip size for the flow rate, speed, nozzle spacing, swath width and pressure that is desired. However, the calibration procedure must be conducted even if the sprayer is equipped with a new nozzle tip(s). Contact OSU Roadside Vegetation

Management personnel for questions on flow rates, changing tip sizes, or other calibration/set-up questions.

### **11.1.2 Carrier Rate**

Carrier rate is the amount of herbicide/water mixture that is sprayed on each treated acre of area. Sometimes referred to as the “application rate,” it is expressed in gallons per acre (GPA). Carrier rates are always available or given on the respective herbicide label(s) of the product(s) being used as well as recommendations from OSU Roadside Vegetation Management personnel. The label(s) will usually have a range of carrier rates that the applicator can utilize, i.e., 20 to 50 gallons per acre broadcast ground applications and 50 to 150 gallons per acre for handgun applications. Carrier rates will change depending on the specific herbicides being used, density of weeds or brush, time of year applications are made, and type of application being made. It is usually most efficient to use the lowest carrier rate possible, but one must consider the aforementioned items before selecting their carrier rate.

### **11.1.3 Ground Speed**

The ground speed of the roadside sprayer is expressed in miles per hour (MPH). The ground speed of the spray rig is often the spray variable that ODOT will determine to give them a specific carrier rate (GPA). Ground speed of the sprayer varies inversely with the spray carrier rate. Inversely means as one variable increases, the other decreases, or vice-versa. Doubling the ground speed of a sprayer will reduce the amount of spray applied per acre by one-half. For example, if a roadside spray rig was

applying 20 GPA at 10 MPH, and the sprayer slowed down to 5 MPH, the carrier rate (GPA) increases to 40 GPM, which also doubles the herbicide rate. Changing the ground speed without recalibrating, will change the carrier rate (GPA) and the herbicide rate. ODOT applicators should learn and become very familiar with their spray equipment and should understand the importance of determining the proper ground speed and how to maintain ground speeds during an application. This is often something that will be learned through experience on a spray rig or from senior ODOT personnel.

#### **11.1.4 Spray Pattern Width or Nozzle Spacing**

The spray pattern width (SW) is the average distance treated by the respective nozzle tip(s), usually expressed in feet on boomless-type sprayers. On boom-type sprayers the spray width may be expressed in inches. Changing the effective spray width per nozzle will change the carrier rate (GPA) which will also change the herbicide rate. The spray pattern width (SW) varies inversely with the carrier rate (GPA). Doubling the spray pattern width (SW) will reduce the carrier rate (GPA) by one-half. For example, a spray rig was calibrated to spray a 22 foot spray swath while delivering 25 GPA. The wind speed picked up or the spray rig changed direction and decreased the swath width to 11 feet. This increased the carrier rate to 50 GPA which doubled the herbicide rate. Under normal spray conditions the spray pattern width for boomless sprayers will fluctuate a few feet, this is simply the nature of the boomless sprayer. But, during an application if a spray pattern width changes more than 1-2 feet and remains at the new position ODOT applicators must make an adjustment to their ground speed to



compensate for the changing spray pattern width. Making these changes will require continuous monitoring of spray pattern width during application and is the main reason why ODOT spray rigs should have a second applicator on the spray rig during applications. ODOT applicators should understand that when the spray rig makes a change in direction, even small changes, the spray pattern width will change and speed will need to be adjusted. To make changing ground speeds easier speed adjustment charts are available (refer to Tables 11.1 – 11.5, use the table that matches your carrier rate).

## 11.2 CALIBRATION FOR SPOT TREATMENT APPLICATIONS

Small capacity sprayers (such as the Solo backpack or 12-volt sprayers) or handguns can be utilized to make spot or broadcast handgun applications along roadside areas. These treatments can be applied using one of two methods. Applications may be made based on either a spray-to-wet or on an area basis. Roadside areas which may require using a small capacity sprayer or a handgun application include: small or irregular shaped areas (such as intersections or rest stops), under guard rails, around signs and delineator posts, noxious weed control, basal and cut stump brush control treatments, bridge ends, brushy backslopes and tall trees. Spray-to-wet applications do not have a true calibration procedure, but simply involve mixing a specific amount of herbicide (percent solution) with a certain quantity of water. Applications made on a spray-to-wet basis involve spraying each targeted weed to the point at which the herbicide/water spray mixture ***begins*** to drip off the foliage. The solution should not run or pour off the leaves, as this would result in an over

application. Depending on the herbicide selected and the size or type of targeted weeds, this method of application requires the applicator to achieve good coverage of the entire weed or brush target to obtain desirable results. A handgun which has a variable pattern is important when making spray-to-wet applications.

Spot applications made on an area basis require the applicator to go through a calibration procedure. This type of application requires a specific number of gallons of herbicide/water mixture to be applied per acre. While possible, it is very difficult for the applicator to be very precise with this specific method of application on a routine basis. When using this method, it is important to avoid an over-application of herbicide that would create an even greater problem. If the following steps and nomograph (Figure 11.1) are used correctly, herbicide applications made on an area basis with either a handgun or small capacity sprayer can be made with positive results.

The following steps are recommended when calibrating a handgun or a small capacity sprayer to make an herbicide application on an **area basis**:

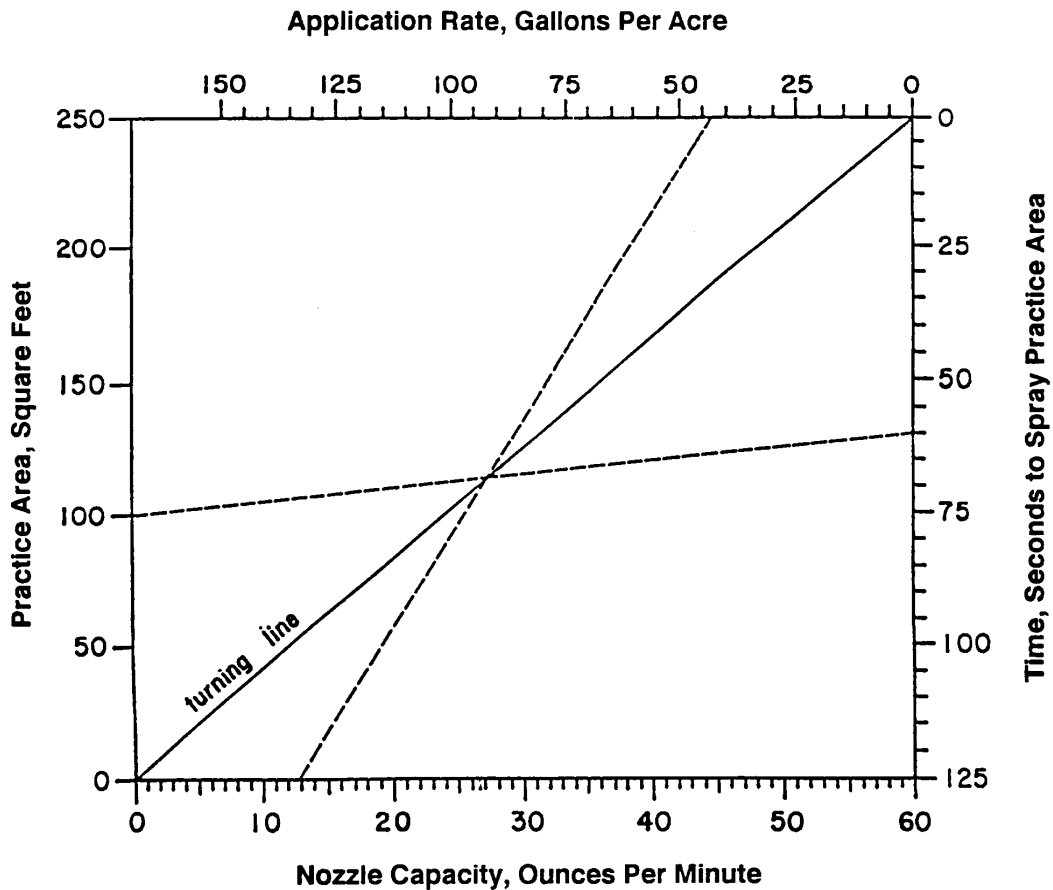
- Step 1. Mark off a given area (i.e., 100 square feet).
- Step 2. Fill the sprayer tank half full with water only. Run the sprayer until the desired pressure is reached.
- Step 3. Use a stop watch or watch with a sweep second hand and check nozzle flow rate by spraying into a measuring container marked in ounces.
- Step 4. On the nomograph (Figure 11.1), draw a straight line from the desired application rate on the top scale to nozzle capacity on the bottom scale.
- Step 5. Draw a second straight line from the size of the practice area on the left hand scale *through the point* of intersection of the first line and the “pivot

line.” The straight line will intersect the right hand scale and indicate the time required to spray the practice area.

Step 6. Spray the practice area with water only, using the time indicated by the nomograph. **Caution** - Be sure to maintain the same pressure throughout the calibration application procedure. Every sprayer, even hand pump up sprayers, needs to be equipped with a pressure gauge.

Example: Use Figure 11.1.

The example shown is for spraying a 100 square foot practice area where the nozzle capacity is 13.0 oz per minute and the desired application rate is 43 GPA.



**Figure 11.1.** Nomograph for Calibrating Handgun or Small Capacity Sprayer Applications Made on an Area Basis.

In this case, 60 seconds are needed to cover the practice area. By knowing the values for any three lines, you can solve for the fourth by drawing two straight lines. You may want to determine the application rate of your sprayer (GPA) for a given rate of coverage (time to spray a known area). You may want to select the proper nozzle size for your type of application.

### **11.3 BOOM-TYPE APPLICATIONS**

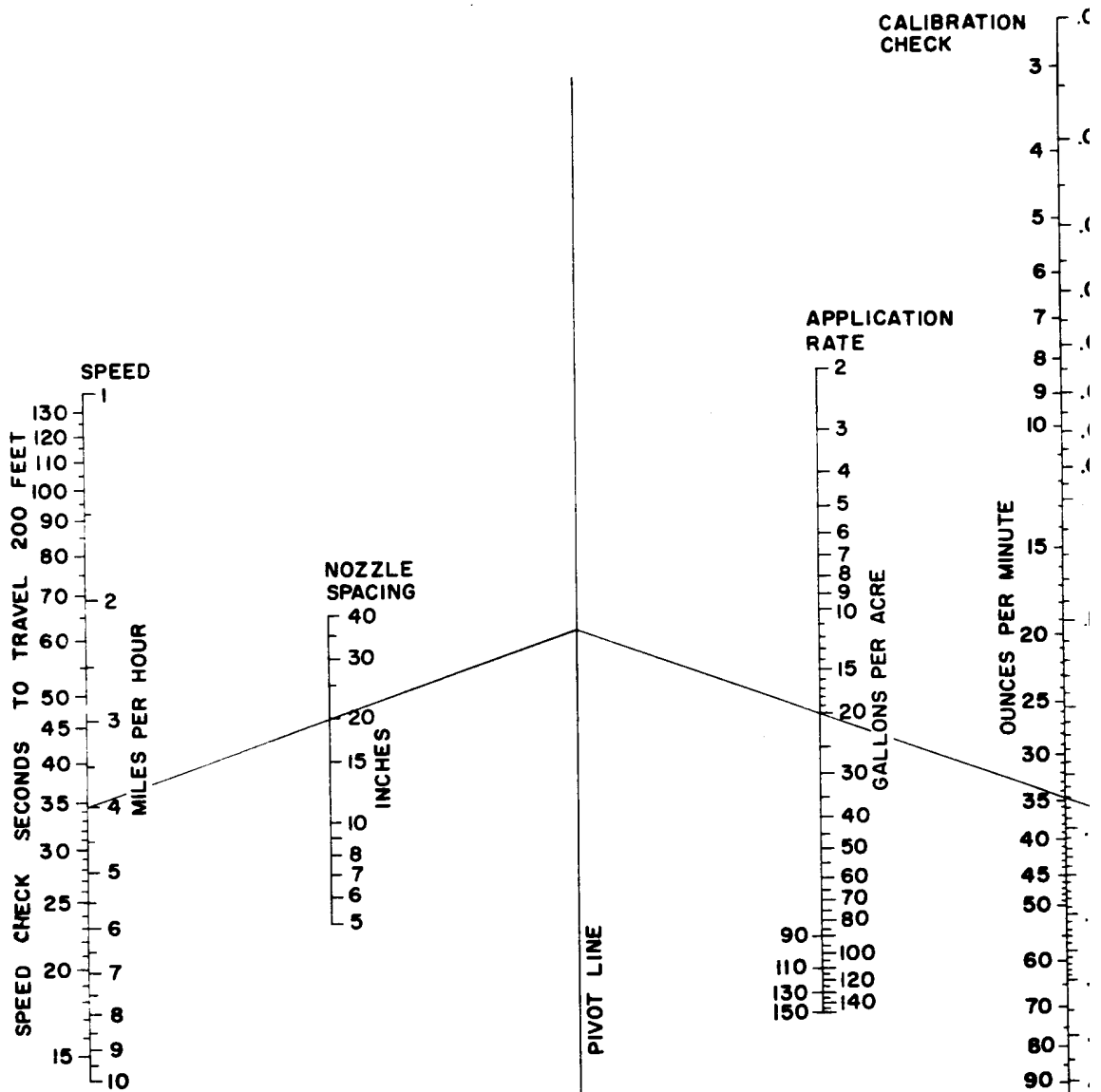
Even though boom-type sprayers are not frequently used on rights-of-way, they can be effective when used on certain roadside situations. Interchanges, wide interstates, noxious weed control, and urban areas are a few of the areas where boom-type sprayers would be very useful. The disadvantages of having to traverse the area to be treated with boom-type sprayers will limit their uses, but they can still be used very effectively to eliminate taller growing weeds in areas which would otherwise require frequent mowing. Ground speeds for boom-type sprayers will be much slower than boomless sprayers and will usually range from 2-4 MPH.

The calibration of a boom-type sprayer is achieved by following these simple steps and using the nomograph (Figure 11.2). Remember that the area to be treated will have to be traversed, so a nozzle size should be selected which will allow you to travel at a reasonable speed (less than 4 mph).

#### **11.3.1 Calibration of Boom-type Sprayers**

1. Add water to the tank.
2. Check all strainers (includes filters and screens) to be sure they are clean.

3. Flush entire sprayer system with clean water.
4. Adjust sprayer system to the desired pressure (25 psi or less).
5. Adjust the spray boom above the ground or plant foliage for uniform coverage of the area. The height should be set so that each nozzle will overlap 30 percent when using the flat-fan spray tips. The height from target weed to the nozzle will be approximately 18 inches with 80 degree tips to 14 inches with 110 degree tips.
6. Check the discharge rate by placing two containers under two different nozzles, and measure the quantity of water discharged in one minute using a stop watch.
7. Pour the water collected from the two containers into a measuring container marked in ounces and then divide the total quantity collected by two. A difference of 5% or more between two tips means they may be worn and should all be replaced.
8. This quantity is the average amount of liquid discharged per minute per nozzle.
9. Measure the distance between the nozzle tips on the spray boom.
10. Determine the carrier rate (gallons per acre) you want to apply. Normally this figure will be 20 to 40 gallons per acre.
11. From the three values obtained in steps 8, 9 and 10, the proper speed can be calculated using a nomograph (Figure 11.2).



Example: Sprayer ground speed is 4 mph, nozzle spacing is 20 inches, and desired application rate is 20 gal./acre.  
 Solution: Using a straight edge, draw a line from 4 mph on "speed line" through 20 inches on "nozzle spacing line" and locate point where line intercepts "pivot line". Now draw a line through intercept point on "pivot line" and through 20 gal./acre on "application rate line" and locate point where line intercepts "calibration check line". Read either 35 oz./min. or 0.27 gal./min. Select nozzle size to give 0.27 gal./min. at desired pressure. Adjust pressure regulator to give a flow rate of 35 ounces/minute from each nozzle.

JEG  
 AGRI. ENGR.  
 DEPT. - O.S.U.  
 PL.

Figure 11.2. Nomograph for Calibrating Boom-Type Sprayers.

Example: Use Figure 11.2.

From Step 8 above, the average amount of liquid discharged per minute per nozzle was 52 ounces. In Step 9, the nozzle spacing measured was 20 inches. From Step 10, the desired carrier rate or application rate was 40 gallons per acre.

Using a straight edge, draw a line from 52 ounces on the “calibration check line” through 40 gallons per acre on the “application rate line” and locate the point where line intercepts the “pivot line.” Now draw a line through the intercept point on the “pivot line” and through 20 inches on the “nozzle spacing line” and locate the point where the line intercepts the “speed line.” Read either 3 miles per hour or 46 seconds to travel 200 feet.

## **11.4 BOOMLESS TYPE APPLICATIONS**

In Oklahoma, boomless sprayers are standard equipment for application of herbicides to highway rights-of-way. The main reason for their popularity is the ability to travel on the paved shoulder while treating the right-of-way. Not having to traverse the area to be treated allows for faster application speeds and a more efficient operation. The three types of boomless sprayer nozzle tips used by ODOT include the off-center, boom buster and solid-stream. Currently ODOT uses boombuster tips on about 80% of their boomless spray rigs, solid-stream tips on 18%, and off-center tips on 2% or less.

### **11.4.1 Off-Center Nozzle Sprayers**

The disadvantages of using a sprayer equipped with an off-center nozzle are drift and lack of adjustment for spray pattern width. The off-center nozzle creates an arc-

shaped pattern that creates many fine spray particles (mist) which will easily drift out of the target area. Drift control additives and maintaining operating pressures near 25 psi or less will help minimize fine spray droplets. Adjustment of the spray pattern width is limited and creates problems along narrow rights-of-way and along on/off ramps. An off-center nozzle set up to treat 25 feet will maintain this pattern even on a right-of-way less than 25 feet. This does not allow for a buffer zone (i.e., zone which is not sprayed) and makes treating the rights-of-way very difficult. Applicators should be aware of this potential problem. If it is impossible to leave a buffer zone, then the application should be made using a handgun, wiper-type herbicide applicator or avoided entirely.

#### **11.4.1.1 Calibration of Boomless Off-Center or Boom Buster Nozzle Sprayers**

1. Add clean water to the tank.
2. Check all strainers to be sure they are clean (includes filters or screens).
3. Flush entire sprayer system with clean water.
4. Adjust sprayer system to the desired pressure (25 psi or less).
5. Place a container under the spray nozzle and catch the discharge for one minute (gallons per minute, GPM). (Suggestion: Wrap a large plastic bag, such as a garbage bag, around the spray head or nozzle and secure it so that the discharge is directed into a large barrel).

Minimum collection time is 30 seconds (then multiply output by 2 for GPM, however, it is best to collect discharge for 60 seconds. This will require at least a 20 gallon container.)

6. Accurately measure the quantity collected in gallons.



7. Set and measure the width of the spray pattern in feet. (At this point, you may wish to refer to the appropriate speed (mph) adjustment chart for boomless sprayer calibration in Section 11.4.4.

8. To calculate the ground speed, we use the following formula:

$$\text{MPH} = \frac{495 \times \text{GPM}}{\text{GPA} \times \text{SW}}$$

MPH = miles per hour

GPM = gallons per minute

GPA = gallons per acre

SW = spray pattern width (feet)

9. Multiply the constant 495 by the discharge rate in gallons per minute (given in Step 5).

10. Divide this quantity by the number of gallons per acre that you want to apply (this broadcast rate is generally 20 to 40 GPA), multiplied by the width of the spray pattern in feet (Step 7).

11. The number you obtain is miles per hour.

Example: Discharge rate = 20 GPM  
Spray width = 25 feet  
Broadcast rate = 40 GPA

$$\text{MPH} = \frac{495 \times 20 \text{ GPM}}{40 \text{ GPA} \times 25 \text{ feet}}$$

$$\text{MPH} = \frac{9900}{1000}$$

$$\text{MPH} = 9.9 \text{ (or 10)}$$

12. As a final calibration check, drive the spray rig in the yard applying water at the ground speed obtained to simulate actual spraying conditions as closely as possible. Remeasure the width of the spray pattern. If there is a difference of more than one foot in pattern width, refigure the above formula using the new spray pattern width or refer to speed adjustment

chart. This final procedure insures a more accurate calibration which helps maintain consistent herbicide rates and weed control results.

Recalibration may be required during the herbicide application. During the time a tank of herbicide/water has been mixed and transported to the application site, weather conditions (primarily wind) could change spray pattern widths. Also a change in direction of the spray vehicle will likely result in a change in spray width. Changing wind speed and direction will dramatically affect the spray pattern width which was used in initial and final calibration steps to determine the ground speed of the spray rig. If wind conditions have changed, the applicator will need to recalculate the ground speed of the spray rig. This calculation can be done in the field by a quick measure of the pattern width and referral to the appropriate speed adjustment chart given in Section 11.4.4. Using the new pattern width and the sprayer flow rate (which should not have changed since initial calibration) the speed adjustment for the spray rig can be easily made. Depending upon the herbicide being used, ***failure to adjust the ground speed of the sprayer could result in poor weed control or damaged bermudagrass.*** These adjustments will require the applicators to visually check the spray pattern width frequently and be aware of changing wind speeds and directions.

#### **11.4.2 Boom Buster Nozzle Sprayers**

In recent years, most ODOT roadside boomless sprayers have been upgraded from the off-center nozzle and retrofitted with the boom buster nozzle tip(s). The technology behind the development of these nozzle tips is noted because of their ability to produce more uniform spray patterns when compared to the old off-center nozzles.

During windy conditions, it appears the integrity of the spray pattern is better maintained than that of equivalent off-center nozzles. All boom buster nozzle tips are machined from solid stainless steel and have replaceable industrial grade nylon diffusers. The boom buster manufacturer states in their literature that tests have shown that this nylon will outlast stainless steel, however, after several years of use we are finding that the nylon diffusers will begin to weather and break after 4 or 5 years of use. When the nylon diffusers chip or break the tip is rendered useless, but it can be sent back to the manufacturer for refurbishing. ODOT applicators should annually check the nylon diffusers in boom buster tips and have a back-up tip on the spray truck once they see any weathering or cracking in the tip. To optimize the pattern achieved by boom buster tips they should be mounted 3-4 feet off the ground and angled upwards at approximately 15 degrees.

#### **11.4.2.1 Calibrating Boom Buster Nozzle Sprayers**

To calibrate boom buster nozzle sprayers, use the same procedure as described in Section 11.4.1.1 for calibrating the off-center nozzle sprayer. If the roadside sprayer is equipped with more than one boom buster nozzle tip, it will be necessary for each tip to be calibrated individually. As spray pattern widths may vary during herbicide application, the appropriate speed adjustment chart(s) are available in Section 11.4.4 for the applicator to utilize if needed to make the necessary changes in speed. If using multiple boom buster nozzles on a spray rig to treat different swath widths, the initial width should be set as follows: 437-R (28 ft), 375-R (20 ft), 260-11R (10 ft) and 180-6R (6 ft).

### **11.4.3 Solid-Stream Nozzle Sprayers**

Another popular boomless sprayer is the solid-stream sprayer. Solid-stream sprayers have gained in popularity during the recent past because of their adjustable spray pattern width.

The solid-stream nozzles, operating at 25 to 30 psi, produce a solid stream of spray mixture which eventually breaks up into droplets. This reduces the amount of fine spray droplets produced and subsequently reduces the potential hazard of off-target drift.

Solid-stream sprayers use a series of nozzles arranged in groups or clusters. Each group, which usually treats an area from six to nine feet, is controlled by an electric solenoid valve which can easily be turned on or off by the applicator. The groups are arranged (during calibration procedures) so that when one group ends its spray width, the next group of nozzles will start its spray width. This creates an even distribution of herbicide, regardless of the number of nozzle groups operating.

A solid-stream sprayer is calibrated in one of two ways. The correct calibration method, for any given sprayer depends on the type(s) and size of solid-stream nozzles which are used. Even though nozzles may be of different design (Veejet versus solid stream), if their flow rates are rated the same they will deliver the same amount of output (GPM) while operating at similar pressures. Therefore, each group of nozzles should be adjusted to cover the same spray width. On other spray rigs, groups of nozzles may have different nozzle sizes. This would cause certain nozzle groups to have higher or lower outputs when operating at similar pressures. These spray rigs require each nozzle group to have higher or lower outputs when operating at similar

pressures. These spray rigs require each nozzle group to be calibrated separately, and the spray width for each group of nozzles would be adjusted according to its specific output. To determine which calibration method to use, follow the basic procedures listed below:

#### **11.4.3.1 Calibration of Solid-Stream Nozzle Sprayers**

##### Basic Procedures

1. Add clean water to tank.
2. Check all strainers, filters and screens to be sure they are clean.
3. Flush entire sprayer system with clean water.
4. Adjust the pressure for each nozzle group to the desired operating pressure (25 to 30 psi).
5. Separately, collect and record the discharge from each nozzle group for one minute, emptying the container between groups.

If the discharge from a nozzle group differs from the others by more than 5%, it is possible that the nozzle sizes in that group are different or are badly worn. Most spray tips will have a model number engraved on the side of the tip. Another way of determining if the various tips have similar outputs is to refer to the manufacturer's catalog using the model number and a given pressure. If the spray rig was designed for the use of similar nozzle group output, replace the nozzles with the correct type and size and calibrate the sprayer using Method I. If the rig is designed for certain nozzle groups to have different flow rates, then calibrate the sprayer using Method II.

## Method I.

1. Follow steps 1 through 4, previously mentioned in the Basic Procedures.
2. Adjust the spray pattern of each nozzle group to have uniform coverage with a few inches of overlap between nozzle groups. Each nozzle group should be adjusted to the same spray width (usually between six to nine feet). Operate all nozzles and check the entire pattern for uniformity and proper overlap between nozzle groups. After all tips have been set, spray water while driving 8-10 mph on a concrete surface. Watch the drying pattern to see if any fine-tuning of the spray tips is needed. The pattern should dry uniformly.
3. Catch output from all nozzles for one minute and measure in gallons (GPM).
4. While all nozzles are spraying, measure the total spray width (SW) to the nearest foot.
5. With this information, the ground speed (MPH) of the spray rig can be calculated as follows:

$$\text{MPH} = \frac{495 \times \text{GPM}}{\text{GPA} \times \text{SW}}$$

MPH = miles per hour  
GPM = gallons per minutes  
GPA = gallons per acre  
SW = spray width (feet)

Example: Using Method I.

Output rate = 12 GPM  
Spray width = 36 feet  
Broadcast rate = 20 GPA  
 $\text{MPH} = \frac{495 \times 12 \text{ GPM}}{20 \text{ GPA} \times 27 \text{ feet}}$

$$\text{MPH} = \frac{5940}{540}$$

$$\text{MPH} = 11.0$$

Method II.

1. Follow steps 1 through 4, previously mentioned in Basic Procedures.
2. Catch the output from each nozzle group, making a note of each group's output in ounces per minute (OPM).
3. Change OPM to gallons per minute (GPM) by dividing by 128.

$$\text{GPM} = \frac{\text{OPM}}{128}$$

GPM = gallons per minute  
OPM = ounces per minute

4. Using the selected ground speed of 11.5 MPH and broadcast rate of 20 GPA, the spray width (SW) may be calculated for a specific nozzle group as follows:

$$\text{SW} = \frac{495 \times \text{GPM}}{\text{GPA} \times \text{MPH}}$$

This calculation will have to be made for each nozzle group which is producing an output that differs by more than 24 fluid ounces from other nozzle groups. The spray width (calculated) should be adjusted so as to apply to the correct amount of carrier per acre.

Example: Using Method II.

Broadcast rate = 20 GPA  
Ground speed = 11.5 MPH  
Output from nozzle Group #1 = 490 oz per minute

a.  $\text{GPM} = \frac{\text{OPM}}{128} = \frac{490}{128} = 3.8$

b.  $\text{SW} = \frac{495 \times \text{GPM}}{\text{GPA} \times \text{MPH}}$

$$\text{SW} = \frac{495 \times 3.8 \text{ GPM}}{20 \text{ GPA} \times 11.5 \text{ MPH}}$$

$$SW = \frac{1881}{230}$$

SW = 8.17 or 8.2 feet

The spray width for nozzle group #1 should be adjusted to treat 8.2 feet. Repeat this procedure for each nozzle group and adjust the spray width as calculated. When properly calibrated, each nozzle group will be applying 20 gallons of carrier (herbicide/water) per acre.

#### **11.4.4 Speed Adjustment Charts**

Several speed adjustment charts have been developed as an aid to the ODOT applicators. These charts have been distributed to ODOT personnel in the past at ODOT CEU training programs and are available at request from OSU Roadside Vegetation Management personnel. The primary purpose in developing the speed adjustment charts was to provide quick reference for ODOT applicators during sprayer calibration procedures. The speed adjustment charts are also very useful when ODOT applicators need to make an adjustment in ground speed during an actual herbicide application due to a change in the spray pattern width. The major advantage in using the speed adjustment chart(s) is the elimination of the need for the ODOT applicator to go through the mathematical steps necessary to obtain the correct ground speed of the sprayer in order to apply the proper herbicide rate. The speed adjustment charts have done this for the applicator. Additionally, these charts are a quick, yet accurate method for obtaining correct ground speed; eliminating the potential for mathematical errors to occur and allowing the ODOT applicator a more effective and efficient use of his/her time.



The following speed adjustment charts have been developed for both the boom buster and off-center spray nozzles. Refer to the recommended appropriate spray nozzle tip (size), nozzle flow rate (GPM), carrier rate (GPA) and spray pattern width (SW) to obtain the correct information for the variables mentioned above. Be sure the numbers “match” before using one of the charts. A speed adjustment table has been produced for each of the most commonly used carrier rates currently used by ODOT crews (40, 35, 30, 25, and 20 GPA). Make sure you are using the table that is consistent with your chosen carrier rate. For assistance in using the speed adjustment charts please contact OSU Roadside Vegetation Management personnel.

**Table 11.1.** Speed Chart For Use With Off-Center OC-150 Or Boombuster 260-11R And 375-R Tips When Using A 20 GPA Carrier Rate.

GPM	effective spray width (feet)																						
	10	11	12	13	14	15	16	17	18	19	20	21	22	23	24	25	26	27	28	29	30		
6.0	14.9	13.5	12.4	11.4	10.6	9.9	9.3	8.7	8.3	7.8	7.4	7.1	6.8	6.5	6.2	5.9	5.7	5.5	5.3	5.1	5.0		
6.5		14.6	13.4	12.4	11.5	10.7	10.1	9.5	8.9	8.5	8.0	7.7	7.3	7.0	6.7	6.4	6.2	6.0	5.7	5.5	5.4		
7.0			14.4	13.3	12.4	11.6	10.8	10.2	9.6	9.1	8.7	8.3	7.9	7.5	7.2	6.9	6.7	6.4	6.2	6.0	5.8		
7.5				14.3	13.3	12.4	11.6	10.9	10.3	9.8	9.3	8.8	8.4	8.1	7.7	7.4	7.1	6.9	6.6	6.4	6.2		
8.0					14.1	13.2	12.4	11.6	11.0	10.4	9.9	9.4	9.0	8.6	8.3	7.9	7.6	7.3	7.1	6.8	6.6		
8.5						14.0	13.1	12.4	11.7	11.1	10.5	10.0	9.6	9.1	8.8	8.4	8.1	7.8	7.5	7.3	7.0		
9.0						14.9	13.9	13.1	12.4	11.7	11.1	10.6	10.1	9.7	9.3	8.9	8.6	8.3	8.0	7.7	7.4		
9.5							14.7	13.8	13.1	12.4	11.8	11.2	10.7	10.2	9.8	9.4	9.0	8.7	8.4	8.1	7.8		
10.0								14.6	13.8	13.0	12.4	11.8	11.3	10.8	10.3	9.9	9.5	9.2	8.8	8.5	8.3		
10.5									14.4	13.7	13.0	12.4	11.8	11.3	10.8	10.4	10.0	9.6	9.3	9.0	8.7		
11.0										14.3	13.6	13.0	12.4	11.8	11.3	10.9	10.5	10.1	9.7	9.4	9.1		
11.5											14.2	13.6	12.9	12.4	11.9	11.4	10.9	10.5	10.2	9.8	9.5		
12.0												14.9	14.1	13.5	12.9	12.4	11.9	11.4	11.0	10.6	10.2	9.9	
12.5													14.7	14.1	13.5	12.9	12.4	11.9	11.5	11.0	10.7	10.3	
13.0														14.6	14.0	13.4	12.9	12.4	11.9	11.5	11.1	10.7	
13.5															14.5	13.9	13.4	12.9	12.4	11.9	11.5	11.1	
14.0																14.4	13.9	13.3	12.8	12.4	11.9	11.6	
14.5																	14.4	13.8	13.3	12.8	12.4	12.0	
15.0																		14.9	14.3	13.8	13.3	12.8	12.4
15.5																			14.8	14.2	13.7	13.2	12.8
16.0																				14.7	14.1	13.7	13.2
16.5																					14.6	14.1	13.6
17.0																						14.5	14.0
17.5																						14.9	14.4
18.0																							14.9

**TABLE 11.2. SPEED CHART FOR USE WITH OFF-CENTER OC-150 OR BOOMBUSTER 260-11R, 375-R, OR 437-R TIPS WHEN USING A 25 GPA CARRIER RATE.**

GPM	effective spray width (feet)																						
	8	9	10	11	12	13	14	15	16	17	18	19	20	21	22	23	24	25	26	27	28	29	30
	vehicle speed (MPH)																						
6.0	14.9	13.2	11.9	10.8	9.9	9.1	8.5	7.9	7.4	7.0	6.6	6.3	5.9	5.7	5.4	5.2	5.0	4.8	4.6	4.4	4.2	4.1	4.0
6.5		14.3	12.9	11.7	10.7	9.9	9.2	8.6	8.0	7.6	7.2	6.8	6.4	6.1	5.9	5.6	5.4	5.1	5.0	4.8	4.6	4.4	4.3
7.0			13.9	12.6	11.6	10.7	9.9	9.2	8.7	8.2	7.7	7.3	6.9	6.6	6.3	6.0	5.8	5.5	5.3	5.1	5.0	4.8	4.6
7.5			14.9	13.5	12.4	11.4	10.6	9.9	9.3	8.7	8.3	7.8	7.4	7.1	6.8	6.5	6.2	5.9	5.7	5.5	5.3	5.1	5.0
8.0				14.4	13.2	12.2	11.3	10.6	9.9	9.3	8.8	8.3	7.9	7.5	7.2	6.9	6.6	6.3	6.1	5.9	5.7	5.5	5.3
8.5					14.0	12.9	12.0	11.2	10.5	9.9	9.4	8.9	8.4	8.0	7.7	7.3	7.0	6.7	6.5	6.2	6.0	5.8	5.6
9.0					14.9	13.7	12.7	11.9	11.1	10.5	9.9	9.4	8.9	8.5	8.1	7.7	7.4	7.1	6.9	6.6	6.4	6.1	5.9
9.5						14.5	13.4	12.5	11.8	11.1	10.5	9.9	9.4	9.0	8.6	8.2	7.8	7.5	7.2	7.0	6.7	6.5	6.3
10.0							14.1	13.2	12.4	11.6	11.0	10.4	9.9	9.4	9.0	8.6	8.3	7.9	7.6	7.3	7.1	6.8	6.6
10.5							14.9	13.9	13.0	12.2	11.6	10.9	10.4	9.9	9.5	9.0	8.7	8.3	8.0	7.7	7.4	7.2	6.9
11.0								14.5	13.6	12.8	12.1	11.5	10.9	10.4	9.9	9.5	9.1	8.7	8.4	8.1	7.8	7.5	7.3
11.5									14.2	13.4	12.7	12.0	11.4	10.8	10.4	9.9	9.5	9.1	8.8	8.4	8.1	7.9	7.6
12.0									14.9	14.0	13.2	12.5	11.9	11.3	10.8	10.3	9.9	9.5	9.1	8.8	8.5	8.2	7.9
12.5										14.6	13.8	13.0	12.4	11.8	11.3	10.8	10.3	9.9	9.5	9.2	8.8	8.5	8.3
13.0											14.3	13.5	12.9	12.3	11.7	11.2	10.7	10.3	9.9	9.5	9.2	8.9	8.6
13.5											14.9	14.1	13.4	12.7	12.2	11.6	11.1	10.7	10.3	9.9	9.5	9.2	8.9
14.0												14.6	13.9	13.2	12.6	12.1	11.6	11.1	10.7	10.3	9.9	9.6	9.2
14.5													14.4	13.7	13.1	12.5	12.0	11.5	11.0	10.6	10.3	9.9	9.6
15.0														14.9	14.1	13.5	12.9	12.4	11.9	11.4	11.0	10.6	10.2
15.5															14.6	14.0	13.3	12.8	12.3	11.8	11.4	11.0	10.6
16.0																14.4	13.8	13.2	12.7	12.2	11.7	11.3	10.9
16.5																14.9	14.2	13.6	13.1	12.6	12.1	11.7	11.3
17.0																	14.6	14.0	13.5	12.9	12.5	12.0	11.6
17.5																		14.4	13.9	13.3	12.8	12.4	11.9
18.0																		14.9	14.3	13.7	13.2	12.7	12.3
18.5																			14.7	14.1	13.6	13.1	12.6
19.0																				14.5	13.9	13.4	13.0
19.5																					14.9	14.3	13.8
20.0																						14.7	14.1
20.5																							14.5
21.0																							14.9
21.5																							14.7
22.0																							14.5

**TABLE 11.3. SPEED CHART FOR USE WITH OFF-CENTER OC-150 OR BOOMBUSTER 260-11R, 375-R, OR 437-R TIPS WHEN USING A 30 GPA CARRIER RATE.**

GPM	effective spray width (feet)																						
	8	9	10	11	12	13	14	15	16	17	18	19	20	21	22	23	24	25	26	27	28	29	30
	vehicle speed (MPH)																						
6.0	12.4	11.0	9.9	9.0	8.3	7.6	7.1	6.6	6.2	5.8	5.5	5.2	5.0	4.7	4.5	4.3	4.1	4.0	3.8	3.7	3.5	3.4	3.3
6.5	13.4	11.9	10.7	9.8	8.9	8.3	7.7	7.2	6.7	6.3	6.0	5.6	5.4	5.1	4.9	4.7	4.5	4.3	4.1	4.0	3.8	3.7	3.6
7.0	14.4	12.8	11.6	10.5	9.6	8.9	8.3	7.7	7.2	6.8	6.4	6.1	5.8	5.5	5.3	5.0	4.8	4.6	4.4	4.3	4.1	4.0	3.9
7.5		13.8	12.4	11.3	10.3	9.5	8.8	8.3	7.7	7.3	6.9	6.5	6.2	5.9	5.6	5.4	5.2	5.0	4.8	4.6	4.4	4.3	4.1
8.0		14.7	13.2	12.0	11.0	10.2	9.4	8.8	8.3	7.8	7.3	6.9	6.6	6.3	6.0	5.7	5.5	5.3	5.1	4.9	4.7	4.6	4.4
8.5			14.0	12.8	11.7	10.8	10.0	9.4	8.8	8.3	7.8	7.4	7.0	6.7	6.4	6.1	5.8	5.6	5.4	5.2	5.0	4.8	4.7
9.0			14.9	13.5	12.4	11.4	10.6	9.9	9.3	8.7	8.3	7.8	7.4	7.1	6.8	6.5	6.2	5.9	5.7	5.5	5.3	5.1	5.0
9.5				14.3	13.1	12.1	11.2	10.5	9.8	9.2	8.7	8.3	7.8	7.5	7.1	6.8	6.5	6.3	6.0	5.8	5.6	5.4	5.2
10.0					13.8	12.7	11.8	11.0	10.3	9.7	9.2	8.7	8.3	7.9	7.5	7.2	6.9	6.6	6.3	6.1	5.9	5.7	5.5
10.5					14.4	13.3	12.4	11.6	10.8	10.2	9.6	9.1	8.7	8.3	7.9	7.5	7.2	6.9	6.7	6.4	6.2	6.0	5.8
11.0						14.0	13.0	12.1	11.3	10.7	10.1	9.6	9.1	8.6	8.3	7.9	7.6	7.3	7.0	6.7	6.5	6.3	6.1
11.5						14.6	13.6	12.7	11.9	11.2	10.5	10.0	9.5	9.0	8.6	8.3	7.9	7.6	7.3	7.0	6.8	6.5	6.3
12.0							14.1	13.2	12.4	11.6	11.0	10.4	9.9	9.4	9.0	8.6	8.3	7.9	7.6	7.3	7.1	6.8	6.6
12.5							14.7	13.8	12.9	12.1	11.5	10.9	10.3	9.8	9.4	9.0	8.6	8.3	7.9	7.6	7.4	7.1	6.9
13.0								14.3	13.4	12.6	11.9	11.3	10.7	10.2	9.8	9.3	8.9	8.6	8.3	7.9	7.7	7.4	7.2
13.5								14.9	13.9	13.1	12.4	11.7	11.1	10.6	10.1	9.7	9.3	8.9	8.6	8.3	8.0	7.7	7.4
14.0									14.4	13.6	12.8	12.2	11.6	11.0	10.5	10.0	9.6	9.2	8.9	8.6	8.3	8.0	7.7
14.5										14.1	13.3	12.6	12.0	11.4	10.9	10.4	10.0	9.6	9.2	8.9	8.5	8.3	8.0
15.0										14.6	13.8	13.0	12.4	11.8	11.3	10.8	10.3	9.9	9.5	9.2	8.8	8.5	8.3
15.5											14.2	13.5	12.8	12.2	11.6	11.1	10.7	10.2	9.8	9.5	9.1	8.8	8.5
16.0											14.7	13.9	13.2	12.6	12.0	11.5	11.0	10.6	10.2	9.8	9.4	9.1	8.8
16.5												14.3	13.6	13.0	12.4	11.8	11.3	10.9	10.5	10.1	9.7	9.4	9.1
17.0												14.8	14.0	13.4	12.8	12.2	11.7	11.2	10.8	10.4	10.0	9.7	9.4
17.5													14.4	13.8	13.1	12.6	12.0	11.6	11.1	10.7	10.3	10.0	9.6
18.0													14.9	14.1	13.5	12.9	12.4	11.9	11.4	11.0	10.6	10.2	9.9
18.5														14.5	13.9	13.3	12.7	12.2	11.7	11.3	10.9	10.5	10.2
19.0														14.9	14.3	13.6	13.1	12.5	12.1	11.6	11.2	10.8	10.5
19.5															14.6	14.0	13.4	12.9	12.4	11.9	11.5	11.1	10.7
20.0																14.3	13.8	13.2	12.7	12.2	11.8	11.4	11.0
20.5																	14.7	14.1	13.5	13.0	12.5	12.1	11.7
21.0																		14.4	13.9	13.3	12.8	12.4	11.9
21.5																		14.8	14.2	13.6	13.1	12.7	12.2
22.0																			14.5	14.0	13.4	13.0	12.5

**TABLE 11.4. SPEED CHART FOR USE WITH OFF-CENTER OC-300 OR OC-150 OR BOOMBUSTER 260-11R, 375-R, OR 437-R TIPS WHEN USING A 35 GPA CARRIER RATE.**

GPM	effective spray width (feet)																				
	10	11	12	13	14	15	16	17	18	19	20	21	22	23	24	25	26	27	28	29	30
	vehicle speed (MPH)																				
11.0	15.6	14.1	13.0	12.0	11.1	10.4	9.7	9.2	8.6	8.2	7.8	7.4	7.1	6.8	6.5	6.2	6.0	5.8	5.6	5.4	5.2
11.5		14.8	13.6	12.5	11.6	10.8	10.2	9.6	9.0	8.6	8.1	7.7	7.4	7.1	6.8	6.5	6.3	6.0	5.8	5.6	5.4
12.0			14.1	13.1	12.1	11.3	10.6	10.0	9.4	8.9	8.5	8.1	7.7	7.4	7.1	6.8	6.5	6.3	6.1	5.9	5.7
12.5			14.7	13.6	12.6	11.8	11.0	10.4	9.8	9.3	8.8	8.4	8.0	7.7	7.4	7.1	6.8	6.5	6.3	6.1	5.9
13.0				14.1	13.1	12.3	11.5	10.8	10.2	9.7	9.2	8.8	8.4	8.0	7.7	7.4	7.1	6.8	6.6	6.3	6.1
13.5				14.7	13.6	12.7	11.9	11.2	10.6	10.0	9.5	9.1	8.7	8.3	8.0	7.6	7.3	7.1	6.8	6.6	6.4
14.0					14.1	13.2	12.4	11.6	11.0	10.4	9.9	9.4	9.0	8.6	8.3	7.9	7.6	7.3	7.1	6.8	6.6
14.5					14.6	13.7	12.8	12.1	11.4	10.8	10.3	9.8	9.3	8.9	8.5	8.2	7.9	7.6	7.3	7.1	6.8
15.0						14.1	13.3	12.5	11.8	11.2	10.6	10.1	9.6	9.2	8.8	8.5	8.2	7.9	7.6	7.3	7.1
15.5						14.6	13.7	12.9	12.2	11.5	11.0	10.4	10.0	9.5	9.1	8.8	8.4	8.1	7.8	7.6	7.3
16.0							14.1	13.3	12.6	11.9	11.3	10.8	10.3	9.8	9.4	9.1	8.7	8.4	8.1	7.8	7.5
16.5							14.6	13.7	13.0	12.3	11.7	11.1	10.6	10.1	9.7	9.3	9.0	8.6	8.3	8.0	7.8
17.0								14.1	13.4	12.7	12.0	11.4	10.9	10.5	10.0	9.6	9.2	8.9	8.6	8.3	8.0
17.5								14.6	13.8	13.0	12.4	11.8	11.3	10.8	10.3	9.9	9.5	9.2	8.8	8.5	8.3
18.0									14.1	13.4	12.7	12.1	11.6	11.1	10.6	10.2	9.8	9.4	9.1	8.8	8.5
18.5									14.5	13.8	13.1	12.5	11.9	11.4	10.9	10.5	10.1	9.7	9.3	9.0	8.7
19.0									14.9	14.1	13.4	12.8	12.2	11.7	11.2	10.7	10.3	10.0	9.6	9.3	9.0
19.5										14.5	13.8	13.1	12.5	12.0	11.5	11.0	10.6	10.2	9.8	9.5	9.2
20.0										14.9	14.1	13.5	12.9	12.3	11.8	11.3	10.9	10.5	10.1	9.8	9.4
20.5											14.5	13.8	13.2	12.6	12.1	11.6	11.2	10.7	10.4	10.0	9.7
21.0											14.9	14.1	13.5	12.9	12.4	11.9	11.4	11.0	10.6	10.2	9.9
21.5												14.5	13.8	13.2	12.7	12.2	11.7	11.3	10.9	10.5	10.1
22.0												14.8	14.1	13.5	13.0	12.4	12.0	11.5	11.1	10.7	10.4
22.5													14.5	13.8	13.3	12.7	12.2	11.8	11.4	11.0	10.6
23.0													14.8	14.1	13.6	13.0	12.5	12.0	11.6	11.2	10.8
23.5														14.5	13.8	13.3	12.8	12.3	11.9	11.5	11.1
24.0														14.8	14.1	13.6	13.1	12.6	12.1	11.7	11.3
24.5															14.4	13.9	13.3	12.8	12.4	11.9	11.6
25.0															14.7	14.1	13.6	13.1	12.6	12.2	11.8
25.5																14.4	13.9	13.4	12.9	12.4	12.0
26.0																14.7	14.1	13.6	13.1	12.7	12.3
26.5																	14.4	13.9	13.4	12.9	12.5
27.0																	14.7	14.1	13.6	13.2	12.7

**Table 11.5.** Speed chart for use with Off-Center OC-300 or OC-150 or Boombuster 260-11R, 375-R, or 437-R tips when using a 40 GPA carrier rate.

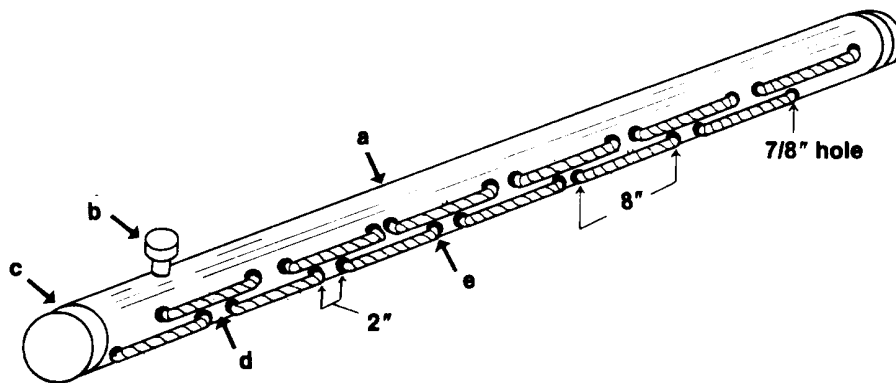
GPM	effective spray width (feet)																						
	10	11	12	13	14	15	16	17	18	19	20	21	22	23	24	25	26	27	28	29	30		
	vehicle speed (MPH)																						
11.0	13.6	12.4	11.3	10.5	9.7	9.1	8.5	8.0	7.6	7.2	6.8	6.5	6.2	5.9	5.7	5.4	5.2	5.0	4.9	4.7	4.5		
11.5	14.2	12.9	11.9	10.9	10.2	9.5	8.9	8.4	7.9	7.5	7.1	6.8	6.5	6.2	5.9	5.7	5.5	5.3	5.1	4.9	4.7		
12.0	14.9	13.5	12.4	11.4	10.6	9.9	9.3	8.7	8.3	7.8	7.4	7.1	6.8	6.5	6.2	5.9	5.7	5.5	5.3	5.1	5.0		
12.5		14.1	12.9	11.9	11.0	10.3	9.7	9.1	8.6	8.1	7.7	7.4	7.0	6.7	6.4	6.2	5.9	5.7	5.5	5.3	5.2		
13.0		14.6	13.4	12.4	11.5	10.7	10.1	9.5	8.9	8.5	8.0	7.7	7.3	7.0	6.7	6.4	6.2	6.0	5.7	5.5	5.4		
13.5			13.9	12.9	11.9	11.1	10.4	9.8	9.3	8.8	8.4	8.0	7.6	7.3	7.0	6.7	6.4	6.2	6.0	5.8	5.6		
14.0			14.4	13.3	12.4	11.6	10.8	10.2	9.6	9.1	8.7	8.3	7.9	7.5	7.2	6.9	6.7	6.4	6.2	6.0	5.8		
14.5				13.8	12.8	12.0	11.2	10.6	10.0	9.4	9.0	8.5	8.2	7.8	7.5	7.2	6.9	6.6	6.4	6.2	6.0		
15.0				14.3	13.3	12.4	11.6	10.9	10.3	9.8	9.3	8.8	8.4	8.1	7.7	7.4	7.1	6.9	6.6	6.4	6.2		
15.5				14.8	13.7	12.8	12.0	11.3	10.7	10.1	9.6	9.1	8.7	8.3	8.0	7.7	7.4	7.1	6.9	6.6	6.4		
16.0					14.1	13.2	12.4	11.6	11.0	10.4	9.9	9.4	9.0	8.6	8.3	7.9	7.6	7.3	7.1	6.8	6.6		
16.5					14.6	13.6	12.8	12.0	11.3	10.7	10.2	9.7	9.3	8.9	8.5	8.2	7.9	7.6	7.3	7.0	6.8		
17.0						14.0	13.1	12.4	11.7	11.1	10.5	10.0	9.6	9.1	8.8	8.4	8.1	7.8	7.5	7.3	7.0		
17.5						14.4	13.5	12.7	12.0	11.4	10.8	10.3	9.8	9.4	9.0	8.7	8.3	8.0	7.7	7.5	7.2		
18.0						14.9	13.9	13.1	12.4	11.7	11.1	10.6	10.1	9.7	9.3	8.9	8.6	8.3	8.0	7.7	7.4		
18.5							14.3	13.5	12.7	12.0	11.4	10.9	10.4	10.0	9.5	9.2	8.8	8.5	8.2	7.9	7.6		
19.0							14.7	13.8	13.1	12.4	11.8	11.2	10.7	10.2	9.8	9.4	9.0	8.7	8.4	8.1	7.8		
19.5								14.2	13.4	12.7	12.1	11.5	11.0	10.5	10.1	9.7	9.3	8.9	8.6	8.3	8.0		
20.0								14.6	13.8	13.0	12.4	11.8	11.3	10.8	10.3	9.9	9.5	9.2	8.8	8.5	8.3		
20.5								14.9	14.1	13.4	12.7	12.1	11.5	11.0	10.6	10.1	9.8	9.4	9.1	8.7	8.5		
21.0									14.4	13.7	13.0	12.4	11.8	11.3	10.8	10.4	10.0	9.6	9.3	9.0	8.7		
21.5									14.8	14.0	13.3	12.7	12.1	11.6	11.1	10.6	10.2	9.9	9.5	9.2	8.9		
22.0										14.3	13.6	13.0	12.4	11.8	11.3	10.9	10.5	10.1	9.7	9.4	9.1		
22.5										14.7	13.9	13.3	12.7	12.1	11.6	11.1	10.7	10.3	9.9	9.6	9.3		
23.0											14.2	13.6	12.9	12.4	11.9	11.4	10.9	10.5	10.2	9.8	9.5		
23.5											14.5	13.8	13.2	12.6	12.1	11.6	11.2	10.8	10.4	10.0	9.7		
24.0											14.9	14.1	13.5	12.9	12.4	11.9	11.4	11.0	10.6	10.2	9.9		
24.5												14.4	13.8	13.2	12.6	12.1	11.7	11.2	10.8	10.5	10.1		
25.0												14.7	14.1	13.5	12.9	12.4	11.9	11.5	11.0	10.7	10.3		
25.5													14.3	13.7	13.1	12.6	12.1	11.7	11.3	10.9	10.5		
26.0														14.6	14.0	13.4	12.9	12.4	11.9	11.5	11.1	10.7	
26.5															14.9	14.3	13.7	13.1	12.6	12.1	11.7	11.3	10.9
27.0																14.5	13.9	13.4	12.9	12.4	11.9	11.5	11.1

## 11.5 ROPEWICK OR WIPER-TYPE APPLICATORS

Ropewick or wiper-type applicators wipe rather than spray a nonselective herbicide/water mixture onto targeted weeds. The ropewick type applicators accomplish this by soaking a series of polyester over acrylic fiber core (P/A) ropes with an herbicide/water mixture until saturated (Figure 11.3). More recent wiper-type applicator technology has resulted in the use of a canvas or canvas-type material “wrapped” around or covering the PVC type of pipewick applicator, replacing the P/A ropes (Speidel applicator). A series of holes are drilled into the PVC pipe which allows the canvas material to become saturated with the herbicide/water mixture. This type of application has the potential to insure a more uniform “wetting” of the canvas as opposed to the P/A ropes. Additionally, it may have the potential of achieving better “coverage” during the application, due to the fact that there is more surface area (canvas) with which the targeted weeds can come into contact.

During application, the wiper-type applicator travels through the area intended for treatment and allows for taller, targeted weeds to come into contact with the applicator wiping apparatus. It is critical that the undesirable plants be taller than the desirable vegetation for this application method to work. Caution in setting the wiper bar height must be used as all desirable plants contacted will also be controlled. The nonselective herbicide will then be applied selectively to the taller plants. Most targeted plants successfully treated will be controlled, however targeted plants that are below the height of the unit will escape treatment. Since the area to be treated must be traversed, this is a time consuming application method. Areas which are severely infested require slower ground speeds and applications in two difference directions to assure better coverage

and desired control. Hoses, manifolds and ropes or canvas must be kept clean at all times to operate effectively and efficiently. It is also important that the manifolds holding the herbicide/water mixture be kept full to assure that ropes and canvas will stay saturated on a sloped area. The wiper-type applicators major advantage is that high winds do not affect their performance. Therefore, there is no problem with off-target drift, even immediately adjacent to sensitive or ultra-sensitive areas. This makes the wiper-type applicator's use in urban areas, intersections, sensitive areas, and narrow rights-of-way practical. The calibration of wiper-type applicators involves pre-mixing of the herbicide/water into the proper proportions. Refer to the specific herbicide labels for recommended proportions to use. Commonly used proportions are 2:1 (water:glyphosate). This is currently the only method available for ODOT to control switchgrass growing in clear zones.



**Figure 11.3.** Typical ropewick applicator showing the components assembled. Materials are (a) 3-inch PVC pipe; (b) capped fill spout – PVC; (c) end cap – PVC; (d) wick of ½-inch diameter soft braided nylon marine rope; (e) rubber bushing (for ½-inch rope) with compression cap.



## 11.6 DIGITAL SPEED CONTROLS AND MONITORS

When the initial ground speed for the herbicide application is calculated, or when the ground speed is adjusted during an application, it is very important that ODOT applicators have an accurate means of setting and/or monitoring ground speed. Using factory equipped speedometers and tachometers may commonly result in an error up to 40 percent at lower speeds. Therefore, it is highly recommended that each ODOT spray rig be equipped with a digital speed monitoring device, such as a Calc-An-Acre® device or equivalent. When properly calibrated, these units allow a very precise (to the nearest 0.1 MPH) measurement of the ground speed of the sprayer. The Calc-An-Acre devices take the guess work out of sprayer ground speeds and help provide for consistent and accurate applications. Digital speed monitoring or accurate low-speed cruise control devices should be standard on all ODOT broadcast spray equipment that is not equipped with injection technology. The small monetary investment in Calc-An-Acres will be returned very quickly by reducing over application of expensive herbicides. The most important reason to use them is they facilitate ODOT applicators making an accurate application which improves the likelihood of achieving suitable weed control results.

Calc-An-Acres can be mounted to ODOT spray trucks using the stock cable/sensor/magnet system or an ad-on Astro II GPS Sensor system can be purchased separately to take the place of the magnet system. The Astro II GPS Sensor is easy to install and proven to be very effective. The stock cable/sensor/magnet or add-on Astro II GPS Sensor will work on all trucks, tractors, and pickups.

# **CHAPTER 12.0 PESTICIDE LAWS AND REGULATIONS**

## **12.01 PURPOSE**

The purpose of this chapter is to overview the Federal pesticide laws, Endangered Species Act, Oklahoma Pollution Discharge Elimination System regulations, Oklahoma Noxious Weed Law, pesticide applicator licensing and certification requirements, and appropriate product storage and handling procedures.

## **12.1 FEDERAL PESTICIDE LAWS**

The original federal law regulating pesticides was enacted in 1947. Our current modern day pesticide law, passed by Congress in 1972 and amended numerous times, is referred to as the Federal Insecticide, Fungicide, and Rodenticide Act or FIFRA. All pesticides are regulated on the federal level by the Environmental Protection Agency (EPA). The EPA is charged by Congress to protect the nation's land, air and water systems. Currently, the EPA administers 11 comprehensive environmental protection laws. Some of these laws include FIFRA, Clean Air Act, Clean Water Act, Safe Drinking Water Act, Comprehensive Environmental Response Compensation and Liability Act ("Superfund") and Resource Conservation and Recovery Act. Through research, development, and technical assistance, EPA generates and disseminates sound science and engineering to support its missions. These efforts provide the data that the EPA needs to set and address priorities in identifying, assessing and managing risks to the public health and to the environment. EPA's research combines the in-house

expertise of agency scientists and engineers with complementary research by universities and nonprofit organizations under a competitive, peer-review program.

All pesticides must be registered with the EPA before they may be manufactured, sold, or imported for sale into the United States. The registration process is both lengthy and expensive, and it allows for comprehensive study of each pesticide to determine both efficacy on the target as well as possible adverse effects to the applicator or environment. Once a pesticide receives registration, all of the data will be summarized on the product's label and material safety data sheet. Under the FIFRA of 1972, all pesticides must be used as directed on their label. There are a few modifications to this rule and they will be discussed later in this chapter. State pesticide laws may exceed federal laws, but they cannot be less stringent.

### **12.1.1 Endangered Species Act**

In 1972 Congress passed the Endangered Species Act (ESA) which required federal agencies including the EPA to ensure that their actions (including pesticide regulation) do not jeopardize an endangered or threatened species. As a consequence of this Act both the U.S. Fish and Wildlife Service (FWS) and the US EPA are responsible for regulating and enforcing the ESA. The FWS determines which pesticides have the potential to affect any listed species or its critical habitat. If a pesticide has the potential to cause adverse effects, labeling restrictions are incorporated into the federal label, preventing the products use in the specific area of the species. The occupied ranges/habitats of an endangered species are communicated to ODOT by one of four methods:

1. Information Bulletins - These bulletins are produced by EPA and the FWS.

The bulletins are referenced on an affected herbicide label making the information enforceable under FIFRA Section 2 (p)(2)(B). Not all herbicides have statements of this nature, only those determined by the FWS to pose a threat to any endangered species.

2. Labels/Supplemental Labels - These labels are produced by the

companies making and selling herbicides that are affected by the ESA. The labels are approved by the EPA as being part of the federal label, making the supplemental label information enforceable under FIFRA.

3. Direct Contact with FWS Endangered Species Specialist.

The information bulletins are the primary document to assist ODOT applicators in determining what species are endangered and the counties in which they reside in the state. As information bulletins are produced, they will be distributed to affected ODOT field divisions by the OSU roadside vegetation management program staff. New information concerning the ESA will be covered thoroughly during fall CEU workshops.

4. EPA Endangered Species Protection Bulletins.

Bulletins are available on-line at <http://www.epa.gov/espp/bulletins.htm>. EPA

bulletins contain the following information:

- Map of county to which it applies
- Description of the species being protected
- Pesticide(s) of concern
- Pesticide use limitations
- Month for which bulletin is valid

**Table 12.1.** Federally Listed Endangered (E) or Threatened (T) Species in Oklahoma<sup>1</sup>.

**Animals--17 species**

- E -- Bat, gray (*Myotis grisescens*)
- E -- Bat, Indiana (*Myotis sodalis*)
- E -- Bat, Ozark big-eared (*Corynorhinus [=Plecotus] townsendii ingens*)
- E -- Beetle, American burying (=giant carrion) (*Nicrophorus americanus*)
- T -- Cavefish, Ozark (*Amblyopsis rosae*)
- E -- Crane, whooping (*Grus americana*)
- E -- Curlew, Eskimo (*Numenius borealis*)
- T -- Darter, leopard (*Percina pantherina*)
- T -- Madtom, Neosho (*Noturus placidus*)
- T -- Mussel, Scaleshell (*Leptodea leptodon*)
- E -- Mussel, winged mapleleaf (*Quadrula fragosa*)
- T -- Plover, piping (*Charadrius melodus*)
- E -- Rock-pocketbook, Ouachita (=Wheeler's pearly mussel) (*Arkansia wheeleri*)
- T -- Shiner, Arkansas river (*Notropis girardi*)
- E -- Tern, interior least (*Sterna antillarum*)
- E -- Vireo, black-capped (*Vireo atricapilla*)
- E -- Woodpecker, red-cockaded (*Picoides borealis*)

**Plants--1 species**

- T -- Orchid, eastern prairie fringed (*Platanthera leucophaea*)

<sup>1</sup>Source: US Fish and Wildlife Service. (Verified January 31, 2010).  
[http://ecos.fws.gov/tess\\_public/pub/stateListingIndividual.jsp?state=OK&status=listed](http://ecos.fws.gov/tess_public/pub/stateListingIndividual.jsp?state=OK&status=listed).

It is now an EPA and ODAFF requirement that as part of normal pesticide record keeping that current EPA Endangered Species Protection Bulletins for each application and each county be maintained. Endangered Species Protection Bulletins can be printed from the EPA website no longer than 6 months prior to the application date. For most ODOT counties this would mean that EPA Endangered Species Bulletins for February through August would need to be downloaded from the website and added to the pesticide records. The EPA Bulletins Live website is <http://www.epa.gov/espp/bulletins.htm>. The website is relatively easy to understand and one can download and print bulletins, if they exist, for each of the counties within

Oklahoma. There are currently no Endangered Species restrictions for any of the herbicides used by ODOT, but, county maps must still be downloaded and printed and become part of the annual recordkeeping. If any additional information on Endangered or Threatened Species is needed, contact ODOT's Biologist at (405)521-3050.

### **12.1.2 Oklahoma Pollutant Discharge Elimination System (OPDES) regulations**

In 1990 the U.S. Environmental Protection Agency (EPA) promulgated regulations for establishing water quality based municipal storm water programs to address storm water runoff from certain industrial and construction activities and from medium and large municipal separate storm sewer systems (MS4's) serving populations of 100,000 or greater. These "Phase I" regulations were incorporated into the existing National Pollutant Discharge Elimination System (NPDES) permit rules that address point source dischargers. ODOT is a Co-Permittee with Oklahoma City and Tulsa under the Phase I regulations. On December 8, 1999, EPA published final regulations that address urban storm water runoff from cities under 100,000 population and counties that lie within the Urbanized Area as defined by the latest US Bureau of Census designation. These cities and other entities, including ODOT, were designated Phase II MS4 regulated areas. The Oklahoma Department of Environmental Quality (ODEQ) presently has primary jurisdiction over permitting and enforcement of the OPDES Storm Water Program for Oklahoma. These "Phase II" cities, counties and other entities, including ODOT in the regulated areas, must develop a comprehensive Storm Water Management Program. The small MS4 storm water management program must include the following six minimum control measures: public education and outreach; public

participation/involvement; illicit discharge detection and elimination; construction site runoff control; post-construction runoff control; and pollution prevention/good housekeeping.

ODOT's Herbicide program is representative of ODOT's environmental stewardship in Oklahoma for Illicit Discharge and Detection and Pollution Prevention / Good Housekeeping and it's activities are documented in the Annual Report to DEQ. The program uses the National Pollutant Discharge Elimination System (NPDES) permitting mechanism to require the implementation of controls designed to prevent harmful pollutants from being washed by storm water runoff into local water bodies.

## **12.2 OKLAHOMA PESTICIDE LAWS AND REGULATIONS**

Oklahoma has passed laws and adopted regulations to implement federal laws and regulations and to deal with unique state pesticide situations. The Oklahoma Department of Agriculture, Food, & Forestry (ODAFF) is the regulatory and enforcement agency in Oklahoma for all pesticide issues. The information that follows summarizes several ODAFF laws and regulations that affect ODOT herbicide programs statewide.

### **12.2.1 Oklahoma's Noxious Weed Law**

In the early 1990s, several Oklahoma legislatures held public hearings and meetings to determine how to best manage the growing numbers of invasive and noxious weeds throughout Oklahoma. Typically, a noxious weed is defined as a non-native (exotic) plant that has the potential to be of both an economic and environmental concern to Oklahoma's agriculture industry. There is also concern that the very

aggressive noxious weeds may replace some of the more desirable but less aggressive native flora. This could result in an unwanted reduction in plant biodiversity. Oklahoma's current noxious weed law requires control of all listed noxious weeds in all 77 counties. By law, any listed noxious weeds (Table 12.2) growing in any Oklahoma county must be prevented from flowering and producing seed by whom ever owns or manages the land.

**Table 12.2.** Noxious Weeds of Oklahoma (June 2005).

<u>Weed Species</u>	<u>Scientific Name</u>
Musk thistle	<i>Carduus nutans</i>
Scotch thistle	<i>Onoprodum acanthium</i>
Canada thistle	<i>Cirsium arvense</i>

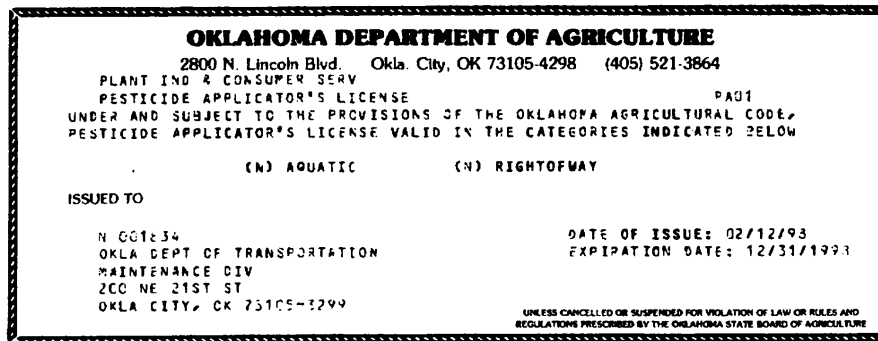
This law makes ODOT responsible for control of all listed noxious weeds growing along the state highway system. The law does not dictate how to prevent seed set. It is possible to successfully use hand removal, mowing, herbicides and sometimes even biological methods in an integrated approach to prevent seed set. The current noxious weed law applies to both public and private lands and puts the burden of identification, notification and enforcement on the ODAFF. Upon a complaint to the ODAFF, an area will be inspected, and if noxious weeds are present, the landowner/manager will be notified as to compliance procedures. If ignored, the state may trespass and implement some type of control at which point the landowner/manager will be billed. The state has the right to contact the county treasurer and the cost of the control can be levied on the property. This cost plus interest shall then be considered a lien against the property. The noxious weed law will give landowners/managers who try to manage noxious



weeds an enforceable law to direct other landowners who are in noncompliance. It boils down to common sense; if my neighbor is putting forth the effort then so should I. With the continued interest of state and federal entities in managing increasing populations of invasive exotic weeds our Oklahoma Noxious Weed Law will likely be amended in the future. The future amendments may include adding additional weed species, landowner cost/share programs, and possible county option management programs.

### 12.2.2 ODOT Pesticide Applicator Licensing and Certification Requirements

By state law, ODOT must apply for a pesticide applicator's license each year. This license is secured annually by Maintenance Division personnel in Oklahoma City and distributed to the field divisions. The license issued to ODOT is valid for applications in category 6 (Right-of-way) and 5 (Aquatic). A copy of the license should be kept in all spray rigs during all applications. An example of an ODOT pesticide applicator's license can be reviewed in Figure 12.1.



**Figure 12.1.** Sample 1998 ODOT Pesticide Applicator's License.

In the last 18 years ODOT has had a very progressive approach to pesticide applicator certification. By law, ODOT needs only a single certified applicator to be

responsible for securing the annual pesticide applicator license. All other ODOT applicators are not be required by law to be certified unless they are using a “Restricted Use” herbicide such as Tordon. Because of ODOT’s commitment to a quality herbicide program, ODOT decided years ago to encourage all applicators to certify in category 6 (Right-of-way). However, in 1994, this encouragement was made into a policy that all herbicides applied by ODOT are to be applied and with supervision by certified applicators (Section 4.6) only. This level of commitment helps show all Oklahomans that ODOT takes its herbicide programs very seriously. Certification and recertification requirements are found in Chapter 9.0.

### **12.2.3 Herbicide Application Record Keeping**

It is required by state law that all ODOT herbicide applications must be recorded and that these records must be maintained for a minimum of two years. This applies to a 1,500 gallon tank load or a 3 gallon backpack application. There are no exceptions to this law. It is also a state law that the records must be given to an agent of the ODAFF if requested. The law is also very specific as to the types of information that should be recorded.

The minimum information as required by state law is as follows:

1. Time, date and place of application.
2. Name and address of applicator.
3. Name and address for whomever used.
4. Legal description of land where used.
5. Tank mix.
6. Dilution rate.
7. Quantity used.
8. Complete trade name, EPA registration number, and EPA establishment number of product(s) used.
9. Target pest or use site.
10. Restricted Entry Interval (REI)
11. A copy of the herbicide(s) label.
12. EPA Endangered Species Bulletin for your specific county & date.

While the law says that the legal description of a treated area must be recorded, this particular record is more geared towards agricultural applications. It would be difficult for ODOT to supply this information. In place of a legal description ODOT applicators should use permanent roadside structures, intersections, businesses, or control sections to positively identify the specific location of an application. An application record sheet should be filled out for each tank load of herbicide or for each day of backpack/handgun applications. On days where several tank loads are sprayed, records such as time, specific location and wind speed and direction will change making documentation very important.

While not required by law, information such as a temperature, wind speed and direction, relative humidity and current sky conditions are also very important to monitor.

This information has been incorporated into the Application Record Sheets that are currently being used by ODOT (Section 4.7). Records, while required by law, can be very beneficial to maintenance personnel. Good quality records document past applications and can be a great source of information when and if personnel changes occur. Application records are also used in cases of drift complaints against ODOT. A well documented herbicide application reflects well on an ODOT spray crew and assists ODAFF inspectors in settling claims against ODOT.

#### **12.2.4 Herbicide Container Storage**

It is the responsibility of all ODOT facilities to store and handle herbicides properly. By law, the minimum storage requirements for full or partially full herbicide containers are as follows:

1. Containers must be stored in a secure, locked enclosure.
2. Containers must be free of leaks.
3. The storage area must be maintained in good condition, without unnecessary debris.
4. The storage area should be identified as such by signs.

It is important for all ODOT facilities to not store herbicides for any longer than necessary. Refrain from buying more herbicide than can be used in a single spray season. All storage areas should prevent any herbicide or adjuvant from freezing or becoming damaged.

### **12.2.5 Herbicide Container Disposal and Recycling**

By law, once a plastic herbicide container has been emptied, it must be immediately triple-rinsed or power-rinsed before disposal. If rinsed immediately upon removing the herbicide, the power-rinse nozzles (Figure 12.2) are very effective and take only 60 seconds per container. The important thing to remember is to rotate the power-rinse nozzle during the cleaning procedure. The triple-rinse process can be done by following these steps:

1. Fill container to approximately 10 percent of the volume with water, replace cap and agitate thoroughly for 60 seconds.
2. Remove cap, pour rinsate into tank, and repeat step 1 two more times.
3. Punch a hole(s) in container to prevent its reuse.

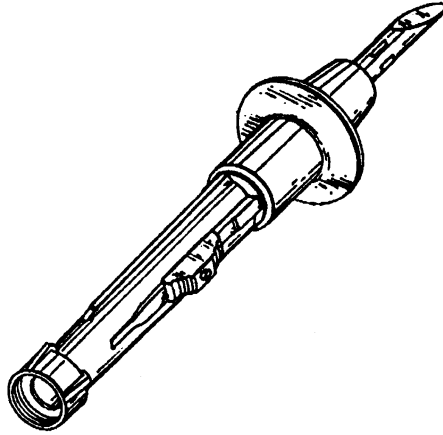
After following proper cleaning procedures, a plastic herbicide container may be disposed of in these three ways:

1. In permitted solid waste facility (sanitary landfill).
2. Returned to the manufacturer.
3. Resale to a third party for recycling or reconditioning.

The proper way of cleaning and disposing of herbicide packaged in paper or plastic bags is to: 1) empty herbicide to the maximum extent, 2) cut sides of bag opening the bag fully, shaking any remaining herbicides into the tank and 3) dispose of in a solid waste facility.

It is estimated that 90 percent of the clean herbicide containers generated by ODOT are made of plastic. Statewide, ODOT generates several thousand containers

annually that have historically been disposed of in local permitted landfills. With landfill spaces filling up and recycling companies beginning to flourish, it has become increasingly popular for pesticide users to recycle their clean empty containers. Thanks to the Agricultural Container Research Council (ACRC), a pesticide container recycling program was initiated in Oklahoma in 1995. The ACRC is a nonprofit, nonpolitical organization funded by chemical manufacturers, distributors, formulators and other Ag industries. The ACRC contracts with regional recyclers providing for both private and public collection sites. All Oklahoma recycling is currently being provided by USAg Recycling, Inc., 40088 Vista, Suite 101C, Pasadena, TX 77504, 1-800-654-3145 (ask for Sam Gibson, President). Participation by ODOT field divisions is encouraged, but it is at their discretion. One of the few drawbacks of participation is that the recycling program requires ODOT to accumulate clean empty containers and store them temporarily until they are recycled. After each of ODOT's two main spray seasons (April and July) each division headquarters could become a collection site. After the second spray season, USAg Recyclers could be requested to recycle the containers at their first opportunity through the area. USAg Recyclers should give receipts to all ODOT participating facilities documenting the number of recycled containers. Data such as this should be maintained and could be released to the public so that ODOT receives credit for their recycling effort.



**Figure 12.2.** An example of a power rinse nozzle used in removing herbicide residues from the container.

### 12.2.6 Major Herbicide Spill Cleanup

While very rare, it is possible that ODOT spray crews may be involved in a major herbicide spill. By law a major spill consists of at least:

10 gallons of liquid herbicide concentrate or

25 pounds of dry herbicide concentrate or

50 gallons of an application mixture (herbicide + water)

If these amounts are involved in an uncontained spill, ODOT is required to contact certain state agencies to ensure that the spill will be cleaned up appropriately.

ODOT must contact the following agencies within 24 hours by telephone and within 3 days by written notice:

Oklahoma State Dept. of Agriculture  
Consumer Protection Division  
P.O. Box 528804  
Oklahoma City, OK 73152  
phone: (405) 521-3864

Oklahoma Dept. of Environmental Quality  
Waste Management Service  
P.O. Box 1677  
Oklahoma City, OK 73101  
phone: (405) 702-5100

Also a copy of all written correspondence concerning major herbicide spills should be sent to the ODOT Environmental Programs Division, ATTN: Storm Water Coordinator or an e-mail to [stormwater@odot.org](mailto:stormwater@odot.org).

In reality, major spills usually occur as a result of an accident. Always take care of injured ODOT personnel or citizens first. If no one is injured, do everything possible to contain the spill within the right-of-way. Several shovels full of dirt can often create a quick temporary dam that will keep the herbicide on the ODOT roadside. If possible, do not allow spill to move to any surface drains or water. ODOT applicators involved in a major spill should contact the county supervisor immediately who will likely in turn contact the field division headquarters. ODOT is well equipped with the equipment to clean up the spill area as long as it has remained out of water and drains. ODOT should remove all contaminated soil to a depth sufficient to guarantee all herbicides have been removed. The contaminated soil may then be moved to a wide right-of-way and distributed (bladed) over a large area (several acres). An area should be selected that has no trees and is relatively flat with little surface drainage from the area. If necessary, after removal of contaminated soil, the spill area may be treated with activated charcoal followed by shallow (1 inch) incorporation to further tie up any remaining herbicide.

### **12.2.7 Backflow Prevention**

By law all ODOT applicators should use some method to prevent the backflow of herbicides during filling, mixing and application operations as appropriate. Several methods are acceptable such as check valves at the water source, in-line check valve



or positive air gap between water and top of fill. Any method complies with the law as long as it prevents backflow. Never put a water hose or line into a spray tank while filling and leave unattended.

### **12.2.8 ODOT Herbicide Spray Packet Information**

When an ODOT engineer or applicator begins working with an herbicide program, it quickly becomes apparent that there is a considerable amount of both printed information and documentation necessary to comply with both state and federal laws. Through annual continuing education workshops, this information is discussed with ODOT personnel. But like many things we do in our jobs, herbicides are a seasonal item. Much of the herbicide information is not used often enough to retain the specifics, so maintaining a quality up-to-date reference file at each ODOT facility is important. Prior to annual herbicide applications, a facility can put together appropriate information in a folder/packet giving the spray crew on-site reference materials. In an effort to have a highly organized and informed spray program, it would benefit each division facility to produce an annual packet of herbicide information and distribute it to all spray crews. It is likely that the information contained in each division's packet will change depending on their specific programs. Table 12.3 lists several types of literature, information and forms that each packet should include (there are other types of documents that may be appropriate for inclusion).

**Table 12.3.** Suggested Reference materials to Be Carried “On-board” by Every ODOT Spray Crew.

<b>Type of Document</b>	<b>Description/Use</b>
Herbicide Label(s) (required by law)	By law each spray rig must have a federal label and any supplemental state labels on the rig during application. It is also a useful document to reference if anyone inquires about the herbicide(s) being sprayed.
Herbicide MSDS(s)	Material Safety Data Sheets should also be included in each packet. Their main use would be a reference to specific toxicological information.
ODOT Herbicide Applicators License	An annual updated copy should be included in the spray packet for proof of licensing.
ODOT Herbicide Applicator Certification Cards	While not included in the packet, all certified ODOT personnel should carry their certification cards during spray season for proof of certification.
Division Herbicide Program Information	This sheet specifically defines what the division has decided upon as far as herbicide(s), rates, timings, surfactants, drift control or other adjuvants. It can also be used for protective clothing statements, overtime approval, night spraying approval, specific no-spray areas and coordinating mowing programs. This sheet is very specific to divisional program and goals.
Sprayer Calibration Worksheet	This worksheet should be filled out prior to the spray season at initial calibration and should eventually become part of the facilities herbicide record keeping.
Pesticide Application Records	Enough blank pesticide application forms should be included so one form can be filled out after each tank load and maintained at the facility.
ODOT Herbicide Program Policy	This policy would be useful to show anyone inquiring about the herbicide program.
Speed Adjustment Tables	These quick reference tables are used to fine-tune ground speed of an operating spray rig during broadcast applications. Currently, ODOT maintains herbicide application rates by manipulating ground speed based on both pattern widths and nozzle flow rates. Used in conjunction with a digital speedometer, the speed charts can be very useful.
Herbicide Spill Cleanup Procedures	Depending on whether it is a major or minor spill it is best to have these procedures readily available to facilitate cleanup and notifications.
List of Sensitive Areas	Within a particular county or interstate area there are usually several specific sensitive areas that should not be treated with any herbicides. Most of these no-spray areas result from requests from landowners. It is best to maintain a copy of these lists to reference, especially for new personnel.

## **CHAPTER 13.0 PUBLIC RELATIONS AND HERBICIDES**

### **13.01 PURPOSE**

The purpose of this chapter is to establish a public relations/herbicide program policy, and to briefly discuss public perceptions and attitudes towards ODOT herbicide programs in order to better understand and communicate program objectives to the public.

### **13.05 INTRODUCTION**

There are as many opinions as to how the public relations aspect of ODOT herbicide programs should be executed as there are applicators for ODOT. There is no single correct way to conduct public relations, as each generation's opinions and perceptions tend to change. A public relations program must also change and be responsive and respectful of public demands. In rural Oklahoma, a long history of agricultural pesticide use often results in a large percentage of the population empathizing with the importance of pesticides as vegetation management tools. In more urban areas, public attitude may focus more on concern over environmental impact than on the necessity of pesticide use for cost-effective vegetation maintenance.

### **13.1 PUBLIC PERCEPTION OF HERBICIDES**

In today's age of electronic communications and mass media, public attitudes and perceptions are formed very quickly. With respect to herbicides, this usually means that after a newspaper article, television spot, or internet report has been released, the

public forms a quick opinion about the new information. What subsequently happens is that an entity such as ODOT or the herbicide manufacturer will try to express their opinions and views on the same subject several days later. The goal would be to educate the public while trying to gain their understanding on that particular issue. In any situation where there are opposing sides, it is human nature to believe and trust in the views to which one is first exposed. It is therefore not surprising when some may become defensive when approached by those having opposing views. It is also true that most citizens will put their trust in whatever side they feel does not have something to gain from a particular item. In other words, when the public reads a newspaper editorial which reflects badly on herbicides and then reads another article from ODOT or the herbicide manufacturer, they tend to believe the newspaper editorial. Because the newspaper editor has nothing apparent to gain in the disagreement and the herbicide manufacturer is in the business of selling herbicide, the public perceives the members of the press as less biased and nobler than those of the herbicide manufacturer or the state employee. While you may or may not agree with these perceptions, they are often present in today's society and understanding them will help build our communication skills. Before one can effectively educate the public on the importance of an integrated RVM program, one must first assess and understand public perception.

## **13.2 PROACTIVE OR REACTIVE HERBICIDE PUBLIC RELATION PROGRAMS**

A proactive approach to an herbicide public relations effort begins with notifying all adjacent landowners prior to an herbicide application. This type of program usually requires running articles in all local newspapers as to the specific treatment information,

timing of the application and a contact person for questions. A proactive approach may also include radio announcements and signage programs. In some of the northeastern states such as Pennsylvania, applicators are required by law to have a pre-notification program. While it is unlikely that Oklahoma will require pre-notification in the near future, one cannot say it won't happen, as we have witnessed pre-notification bills submitted to both the Oklahoma House of Representatives and Senate Agriculture Committees in the past. There are advantages and disadvantages to a proactive herbicide public relations program. However, it is usually the case that a state DOT will not voluntarily begin a proactive program unless new legislation requires it.

A reactive approach to an herbicide public relations program effort is based on the idea that educating and promoting ODOT herbicide programs will be dealt with on a one-on-one basis. A reactive program does not include any type of mass pre-notification or any other public announcement of future herbicide applications. What usually occurs in a reactive program is that ODOT interacts with the public only after an herbicide program complaint or concern has been raised. For the most part ODOT spray crews have developed a positive professional reputation in the state. This reputation should be maintained through continued efforts of applicator training, accurate herbicide applications, and updating of application equipment. Each ODOT facility receives a relatively small number (0-10) of phone calls or personal interactions each year concerning their herbicide program. Each of these inquiries should be dealt with in a serious professional manner to educate and resolve the problem or concern. The OSU RVM personnel are available for assistance if needed. In many cases it is important to remember that a complainant may already have their mind made up, so it is

unlikely that one will be able to change it. In cases such as these, supply these individuals with their requested information and hope they gain a little understanding. Many calls or complaints could be from people whom are curious or interested in what herbicide is actually being sprayed. In these cases, an educational effort may reap great benefits.

By far, most Oklahomans appreciate the roadside vegetation management programs, including herbicide applications that ODOT provides throughout the state. There is rarely a problem associated with mowing or hand removal of vegetation. It is the use of herbicides that concerns a small but sometimes vocal sector of the public. These individuals are often uninformed concerning herbicide use benefits/risks, yet they still provide ODOT maintenance workers with the majority of their public relations interactions.

### **13.3 FORMAL COMPLAINT PROCEDURES WITH THE ODAFF**

Before a formal complaint can be processed against an ODOT herbicide application, the complainant must submit a written complaint to the Oklahoma Department of Agriculture, Food, & Forestry (ODAFF). Upon receipt of a written complaint, the ODAFF will notify the complainant in writing of its receipt within two working days. ODOT will also be notified within two days in writing which will include an ODAFF request for herbicide treatment information such as labels and spray records. An ODAFF inspector will likely inspect the complaint site and it would be helpful if the ODOT county supervisor were present to verbally communicate ODOT herbicide program information on-site. When ODOT receives notification of a formal complaint, it

would be beneficial to contact the ODAFF by phone and to inquire what inspector will cover the complaint. The inspector can then be contacted and a request can be made to be on-site. The inspector, at their discretion, may take soil and tissue samples which may be used to determine if any illegal herbicide residues are present. The samples will be sent to the ODAFF lab in Oklahoma City for analysis. They will usually have a great bearing on the resolution of the complaint. The ODAFF lab can test for most but not all herbicide residues. If there is no visual evidence of herbicide off-target damage, and samples are residue free, it is unlikely that ODOT will be cited. The complainant will be notified in writing within seven working days after final ODAFF resolution of the complaint.

#### **13.4 INFORMAL COMPLAINT PROCEDURES WITH THE ODOT**

The activity of spraying herbicides along Oklahoma roadsides by ODOT personnel is highly visible to the public. Because of this, the operation may be unusually open to public criticism. However, most of the potential criticism may be avoided if the applicator is properly trained. The applicator should be aware of and considerate of public concerns and use extra care when applying herbicides. Regardless of how cautious the applicator may be during the herbicide application, invariably a problem with a landowner will occur. Eventually, someone will have an informal complaint or problem as a result of ODOT making an herbicide application adjacent to their property. Any complaint made directly to ODOT personnel would be considered an informal complaint. Any complaint filed with the ODAFF is a formal complaint. The steps listed below are recommended ODOT procedures following an

informal herbicide complaint. Following these steps a list of personnel who may be contacted with questions about herbicides.

#### Recommended ODOT Procedures Following an Informal Herbicide Complaint

1. Whether the complaint is made in person or by phone, ODOT should document, on paper, basic information of the complaint and schedule a meeting with complainant to review complaint site as soon as possible.
2. Supervisor's should be notified the day the complaint is made.
3. Supervisor's should notify appropriate division maintenance personnel if the complaint is of serious nature on the day of complaint or day of the initial site inspection.
4. Division personnel and supervisor should schedule (within 2 days of initial inspection) a meeting with complainant at complaint site. If necessary, OSU personnel would be available to assist at this 2<sup>nd</sup> inspection.
5. ODOT and OSU personnel must form their own opinion as to whether there appears to be a justifiable complaint. One should try to be unbiased. It would be important at the 2<sup>nd</sup> inspection for ODOT to document the complaint site with photographs, comments, and plant and/or soil samples as appropriate. ODOT can use their pesticide application record sheet(s) to provide documentation of recent applications adjacent to complaint site. Information such as herbicide labels and MSDS sheets should be on hand.

If it is obvious to ODOT and OSU personnel that the complaint is unjustifiable, try to satisfy complainant with suggestions as to the cause of symptoms or damage (be cautious and respectful). If it is obvious to ODOT and OSU personnel, and other



personnel attending any of the 2<sup>nd</sup> inspection, that the complaint is justifiable, the complainant should be encouraged to file a formal complaint with the ODAFF.

6. If a formal complaint is not filed, all documentation pertaining to the complaint should be filed for future reference. If a formal complaint is filed, it would be in the best interest of ODOT to request to be present when the ODAFF inspector examines the complaint site. The inspection will usually occur soon after the formal complaint is filed.

7. If at any point during the herbicide complaint procedure, it becomes apparent that the complainant may contact media sources (newspaper, television, etc.), then it would be important that the respective ODOT division administrative personnel (including appropriate maintenance personnel) be aware of the intentions and actions of the complainant. This would enable ODOT, if deemed necessary, to prepare an appropriate response to such actions.

### **13.5 CONTACT LIST FOR QUESTIONS ABOUT HERBICIDES**

#### ODOT Personnel

Division Engineer:

Maintenance Engineer:

Assistant (Area) Main. Eng.:

County Supervisors:

Other:

#### State Cooperative Extension Personnel

Extension Associate (Roadsides): Doug Montgomery, Office: 405-744-4191 or Cell: 405-747-5755, email: doug.montgomery@okstate.edu

Extension Associate (Roadsides): Craig Evans – Office: 405-744-4085 or Cell: 405-747-8701, email:crag.evans@okstate.edu

#### Chemical Company Representatives

Monsanto (Concerning Roundup Pro Concentrate, Aquamaster, Campaign, Outrider):

DuPont (Concerning Oust XP, Karmex, Krenite S, Escort XP):

Dow AgroSciences (Concerning Garlon 4 Ultra or 3A, Transline, Tordon K, Milestone VM):

Syngenta (Concerning Vanquish):  
BASF (Concerning Overdrive, Arsenal, Plateau):  
Other:

Oklahoma State Department of Agriculture, Food and Forestry:  
Consumer Protection Division/OKC: 405-521-3864  
Local Field Inspector:

---

---

---

Oklahoma State Department of Environmental Quality  
Waste Management Service/OKC: 405-702-5100

### **13.6 NO-SPRAY ROADSIDES/GOOD NEIGHBOR PROCEDURES**

While not an ODOT policy or state law, there are some sections of roadside rights-of-way that should not be treated with herbicides. For a variety of reasons, whether environmental, legal or even personal, these roadsides should be dealt with very sensitively. It is likely that the only management tools that can be used in these areas are mowers or weed eaters. The ultimate decision of whether or not a particular roadside is treated with herbicides lies in the hands of supervisors and applicators. He/she is the person with control of the final decisions and applications and must bear the responsibility of knowing where the no-spray areas are located.

The key to managing no-spray areas is maintaining an up-to-date list of all no-spray areas within a maintenance area. Any landowner making a verbal or written request should be included along with obvious no-spray areas. Regardless of what the roadside looks like, the roadside frontage to these landowners should not be treated unless they specifically requested to do otherwise. Additional no-spray areas are any and all businesses or home frontages that are maintained as lawns up to the edge of the shoulder. Also, be extremely cautious of the locations and proximity of flower or

vegetable gardens and fruit orchards. These plants can be very sensitive to herbicides along with the fact that many of these areas involve edible commodities and the possible creation of illegal residues on these crops. While the small amount of residue would likely not harm anyone, it is imperative that residues be prevented. Any roadside right-of-way which is too narrow to be treated with existing broadcast spray equipment because it would not leave an adequate buffer zone, should not be treated with an herbicide. The potential for drift to private property in these cases is very high and might justify the site to be a no-spray area. Any roadside area that has a permanent surface water area on or very close to an area intended for herbicide application qualifies as a no-spray area (if surface water areas need to be treated with a herbicide they must be treated with an aquatic-approved herbicide such as glyphosate (aquatic), Garlon 3A, or Habitat). Any roadside right-of-way which is a habitat for any threatened or endangered species should not be treated with any herbicide. This area is discussed in more detail in Chapter 12.1.1.

# **CHAPTER 14.0 ODOT APPROVED HERBICIDE AND ADJUVANT LIST (AHAL) PROGRAM**

## **14.01 PURPOSE**

The purpose of the Oklahoma Department of Transportation (ODOT) Approved Herbicide and Adjuvant List (AHAL) is to provide a list of herbicides and adjuvants that have met minimum standards for efficacy and compatibility. The AHAL facilitates ODOT purchasing and using quality products that meets the Department's needs.

## **14.1 INTRODUCTION**

At the request of ODOT Maintenance personnel, the Oklahoma State University roadside vegetation management team was asked to cooperatively produce and execute a formal program where all herbicides (off-patent generics and new patent-protected herbicides) and some adjuvants are subjected to research-based performance standards. Products that meet minimum performance criteria will then be listed on the ODOT AHAL, making this document a critical reference for both ODOT herbicide contracting efforts and small purchases made by ODOT. This basic research procedure has been conducted for more than 30 years by OSU as a part of the Joint Research Projects between ODOT and OSU. However, the ODOT AHAL Program was not formalized until 2004. At this time the AHAL Program has been adopted by ODOT as policy for purchasing all herbicides and appropriate adjuvants. The remainder of this chapter is the formal AHAL Policy.

## **14.2 ODOT APPROVED HERBICIDE AND ADJUVANT LIST (AHAL)**

### **POLICY**

Only the products listed on the Approved Herbicide and Adjuvant List (AHAL) are approved for the ODOT Statewide Herbicide Contract. These herbicide/adjuvant items meet the minimum criteria set by ODOT. Any product not on the AHAL is not eligible for inclusion as a contract bid item in any upcoming bidding process. Herbicide/adjuvant products must meet minimum criteria before they will be placed on the current AHAL. Failure to meet one or more of the criteria will result in non-approval. The AHAL is updated annually and any listed products that fail to maintain minimum approval criteria will be removed along with any other products ODOT decides to remove. Manufacturers and distributors are encouraged to resubmit non-approved products at a later date once minimum approval criteria is met.

### **MINIMUM CRITERIA FOR HERBICIDES.**

1. All herbicides must maintain current registrations with the Environmental Protection Agency (EPA) and Oklahoma Department of Agriculture, Food & Forestry (ODAFF). Current registration numbers must be included on the submission form. Different, or changed, herbicide formulations of the same active ingredient will require separate approval or re-approval. Efficacy and compatibility testing involving herbicide active ingredients that are on the current ODOT AHAL will not be initiated until both EPA and ODAFF registration numbers are provided on the submission form.

2. The final submission packet for all herbicides must include a hard-copy of the most current EPA and/or supplemental EPA labels and/or ODAFF supplemental labels (24-C or 2ee if applicable). All labels and/or supplemental labels must clearly state the identification of active ingredients, the concentration of both active and inert ingredients and recommended product use rates. Special attention will be paid to surfactant loading in applicable herbicide products. Herbicides formulated with surfactants that do not state surfactant percentage loads on their labels should submit this information on the herbicides AHAL submission form.
  
3. The final submission packet for an herbicide active ingredient not on the current ODOT AHAL will require a sample product submission to the Oklahoma State University Roadside Vegetation Management (OSU RVM) Research Program to conduct efficacy and compatibility testing. All testing and data analysis will occur prior to inclusion on the current ODOT AHAL. A minimum of 1 pint (liquid herbicide) or 1 pound (dry herbicide) must be submitted for testing purposes. Unused untested product will be disposed of as per label directions.
  
4. All herbicides require a minimum of efficacy and compatibility testing prior to inclusion in the ODOT AHAL. Efficacy testing involving an herbicide

active ingredient(s) that is not on the current ODOT AHAL will involve a minimum of 2 seasons (years) of efficacy data on roadside weed control and bermudagrass injury. Efficacy testing involving herbicide active ingredients that are on the current ODOT AHAL will involve a minimum of 1 season (year) of efficacy data on roadside weed control and bermudagrass injury. Efficacy data must include a minimum of 15, 30, and 60 days-after-application evaluations on roadside weed control and bermudagrass injury as compared to current ODOT standard treatment(s). If all other pre-approval criteria are met a product would likely be available for inclusion in the ODOT Statewide Herbicide Contract the year following the final year of efficacy and/or compatibility testing. Efficacy research involving herbicide active ingredient(s) that are not on the current ODOT AHAL must be provided by the OSU RVM Research Program. Contact OSU RVM Research Program personnel for current scheduling and pricing of research. Efficacy data involving herbicide active ingredient(s) that are on the current ODOT AHAL can be provided by the OSU RVM Research Program or similar data will be accepted from another Land Grant University Research Program. Efficacy data from a Land Grant University, other than Oklahoma State University, must be accompanied with contact information (name, address, and phone number) of the researcher(s) (See Appendix A). All efficacy testing done by the OSU RVM Research Program will also include compatibility testing. Efficacy data submitted from another Land Grant University Research Program

that does not include compatibility data will require compatibility testing before inclusion on the ODOT AHAL. Efficacy and compatibility test data from manufacturers/distributors internal research will not be accepted.

### **MINIMUM CRITERIA FOR ADJUVANTS.**

1. All adjuvants (mainly drift control products), liquid or dry forms, require a minimum of compatibility testing with current standard ODOT broadcast herbicide treatments. A minimum of 1 pint (liquid adjuvant) or 1 pound (dry adjuvant) must be submitted for testing purposes. Unused untested product will be disposed of as per label directions. Different or changed adjuvant formulations of a specific name brand adjuvant will require separate approval or re-approval. Compared to herbicide formulations, it is much more difficult to monitor formulation changes in adjuvants. Therefore, manufacturers/distributors are encouraged to submit new or changed formulations for compatibility testing. Compatibility testing should be conducted using a standard jar test method (Appendix C). Compatibility testing should include, but is not limited to, all herbicide treatments currently used by ODOT in major broadcast spray programs that require the use of drift control products (ODOT Policy Number D 504-1). Adjuvants should be tested using current standard ODOT herbicide rates and carrier rates. Drift control product rates evaluated should be those recommended on the products label for application conditions as closely



related to ODOT roadside programs as possible. Compatibility research can be supplied by the OSU RVM Research Program or similar data will be accepted from another Land Grant University Research Program. Contact OSU RVM Research Program personnel for current scheduling and pricing of research. Compatibility data from a Land Grant University other than Oklahoma State University must be accompanied with contact information (name, address, and phone number) of the researcher(s) (See Appendix B). Compatibility data from manufacturers/distributors internal research will not be accepted.

2. Certain types of adjuvants are exempt from the pre-approval process as far as compatibility testing. The following types of adjuvants are currently exempt: non-ionic surfactants, non-ionic surfactants (aquatic approved), sprayable grade ammonium sulfate, water soluble dyes, oil soluble dyes, and activated charcoal clean-up products. These types of adjuvants need only meet ODOT herbicide contract bid specifications to be considered for possible awards.

**AHAL PRODUCT (HERBICIDES AND/OR ADJUVANTS) SUBMISSION**  
**REQUIREMENTS**

A product's final submission packet must include the following:

- completed submission form
- current and legible EPA/Supplemental label(s), ODAFF supplemental label (24-C or 2ee if applicable), or hard-copy product label
- complete efficacy research data packet (required for all herbicide products, See Appendix A)
- complete compatibility research data packet (required for all drift control products and herbicides, See Appendix B)

Recommendations concerning approval or non-approval decisions will be made within 30 days of the date that a complete final submission packet is received by Oklahoma State University (OSU) Roadside Vegetation Management (RVM) Research personnel. The final decision on approval will be mailed by ODOT to the manufacturer and/or distributor contact person within 30 days of receipt of the OSU RVM Research Program recommendation of approval or non-approval.

For Research Inquiries Contact: Doug Montgomery  
Oklahoma State University  
Roadside Vegetation Management Research Program  
358 Ag Hall  
Stillwater, OK 74078-6027  
(405) 744-4191; 8-5 M-F  
doug.montgomery@okstate.edu

### Approved Herbicide and Adjuvant List (AHAL) Submission Form

Date:
Product Trade Name:
Product Formulation:
Product Active Ingredient(s):
Product Active Ingredient(s) Concentration:
Product Inert Ingredient(s) Concentration:
Manufacturer:
Manufacturer Contact:
Name:
Address:
Phone Number:
E-mail:
EPA Registration Number:
ODAFF Registration Number:
EPA/ODAFF Supplemental label numbers (24-C/2ee):

Send Submission Form & Packet To: Doug Montgomery, Oklahoma State University,  
358 Ag Hall, Stillwater, OK 74078.

# **APPENDIX A**

## **REQUIREMENTS FOR EFFICACY DATA PACKET**

# REQUIREMENTS FOR EFFICACY DATA PACKET

1. Efficacy data is required for all herbicides being submitted for inclusion in the Approved Herbicide and Adjuvant List (AHAL).
2. Efficacy data must be generated using labeled product information.
3. Efficacy data must be generated using current standard weed control research equipment, techniques, and methods.
4. Efficacy data for an herbicide active ingredient not on the current ODOT AHAL will be from a minimum of two growing seasons with three treatment replications per season.
5. Efficacy data for an herbicide active ingredient that is represented on the current ODOT AHAL (i.e. generic herbicides) will be required from a minimum of one growing season with three treatment replications.
6. Efficacy data on control of specific weed problems found along Oklahoma roadsides is preferred. This would include but is not limited to the following weed species:
  - A. Winter Annual/Biennial/Perennial Weeds
    1. downy brome
    2. cheat
    3. annual ryegrass
    4. hairy vetch
    5. musk thistle
    6. scotch thistle
    7. sweet clover
    8. wheat and/or other cereal grains
  - B. Summer Annual/Biennial/Perennial Weeds
    1. johnsongrass
    2. Illinois bundleflower
    3. field bindweed
    4. kochia
    5. crabgrass spp.
    6. foxtail spp.
    7. pigweed spp.
    8. silver bluestem
    9. common Bermudagrass (total vegetation control)
7. Efficacy data on herbicide phytotoxicity to common bermudagrass must also be submitted.

8. Efficacy data must be included as a part of a summary report that clearly and concisely describes the materials and methods, methods of treatment application, experimental design, method of data collection (i.e. visual, plant counts, etc.), the scale used to assess weed control and phytotoxicity, data analysis and discussion of results.
9. Efficacy data packet must include product performance evaluations at 15, 30, and 60 days-after-application.
10. Efficacy data should be subjected to analysis of variance (ANOVA) and treatment means should be separated using an appropriate separation test at the 90% confidence level, also known as  $p=0.10$ , also known as probability ( $p$ ) of a greater F value = 0.10, also known as  $p > F = 0.10$ .
11. All efficacy testing should include comparison of the new treatments vs current ODOT standard treatments (see most current OSU publication *E-958: Suggested herbicides for roadside weed control*). OSU RVM program personnel may be contacted for recommendations on standard treatments.
12. Research should be conducted on roadside areas or areas which are being managed with no supplemental fertilization or irrigation.

## **APPENDIX B**

REQUIREMENTS FOR COMPATIBILITY RESEARCH PACKET

## **REQUIREMENTS FOR TANK MIX COMPATIBILITY RESEARCH PACKET**

1. Tank mix compatibility performance data is required for all herbicides and adjuvants (drift control products) being submitted for inclusion on the Approved Herbicide and Adjuvant List (AHAL).
2. Compatibility data must be generated using adjuvant labeled information.
3. Compatibility data must be generated using the current standard tank mix compatibility jar test method.
4. All adjuvants should be tested for compatibility with current ODOT broadcast herbicide products and treatment rates.
5. Compatibility testing should include but is not limited to the following treatments (rates):
  - A. Campaign + Ammonium Sulfate (2 pts./A + 17 lbs./100 gal. of water)
  - B. MSMA (2 qts/A)
  - C. Roundup Pro Concentrate (1 qt./A)
  - D. Honcho Plus (1 qt./A)
  - E. Roundup Pro Concentrate + Oust XP (1 pt. + 1.0 oz./A)
  - F. Roundup Pro Concentrate + Outrider (1 pt. + 1.0 oz./A)
  - G. Vanquish + NIS (1 qt./A)
  - H. Overdrive + NIS (4 oz./A)
  - I. Transline + NIS (8 oz./A)
6. Compatibility data generated must be accompanied by clear, concise descriptions of how data was collected (i.e. visual) and clear a description of all observations.
7. Compatibility data must include observations taken immediately after mixtures are made and shaken, referred to as “time zero” observations as well as 30 minutes after initial shaking (before re-shaking), and immediately after re-shaking.
8. Compatibility data should be presented in a summary report describing the materials and methods utilized and should discuss the results or findings of the research.



## **APPENDIX C**

PROCEDURES FOR TANK MIX COMPATIBILITY JAR TEST

## PROCEDURES FOR TANK MIX COMPATIBILITY JAR TEST

1. Mix all herbicides together first before attempting to add any adjuvant.

Mixing order for herbicides (unless otherwise stated on label):

- a. AMS
- b. dry herbicides
- c. liquid soluble
- d. liquid emulsifiables

Mixing should occur by slowly inverting bottle 3 or 4 times after each product is added. This should be adequate to mix all liquids but dry herbicides will require repeating the inversion process several more times over a 1-3 minute period or until all dry herbicide prills are visibly dispersed. Inverting bottles should be done to prevent excessive foaming if at all possible. All herbicides & AMS should be thoroughly mixed before attempting the addition of any adjuvants being tested.

2. Add the appropriate adjuvants to the herbicide mixture one component at a time, followed by slowly inverting the mixture 10 times. Evaluate the mixture immediately and move on to the next adjuvant, repeating the process. Once the first mixture is evaluated, make a note of the time on the score sheet. Once all evaluations are made with a particular herbicide treatment, allow the bottles to set undisturbed for 30 minutes (or as close as possible).
3. After 30 minutes, evaluate each of the bottles for the 2<sup>nd</sup> time. It is acceptable to pick up the bottles but this should be done carefully so as not to disturb the mixture. After evaluation, place each bottle down undisturbed. It might be helpful to hold the mixture with a bright light (light bulb, window) behind the bottle to backlight the mixture, making potential incompatibilities more visible. When the last mixture is evaluated proceed immediately to the 3<sup>rd</sup> evaluation.
4. The 3<sup>rd</sup> and final evaluation occurs by slowly inverting the first bottle 10 times followed by evaluation. Repeat for the rest of the mixtures.
5. Each testing procedure will have 3 evaluations. Incompatibility could be in the form of excessive foaming, sludges, gels, particulates, globules, and formation of layers just to mention a few. Incompatibility occurs when these forms are created instantly or over time and will not easily disperse with final agitation.